



Installation manual

Terra AC(UL 80A)

Copyright

All rights to copyrights, registered trademarks, and trademarks reside with their respective owners.

Copyright © ABB EV Infrastructure. All rights reserved.

Contents

1	About this document.....	6
1.1	Function of this document	6
1.2	Target group	6
1.3	Revision history	6
1.4	Language.....	6
1.5	Illustrations.....	6
1.6	Units of measurement	6
1.7	Typographical conventions.....	6
1.8	How to use this document	6
1.9	General symbols and signal words	7
1.10	Special symbols for warnings and dangers	8
1.11	Related documents	8
1.12	Manufacturer and contact data	8
1.13	Abbreviations	9
1.14	Terminology	9
1.15	Orientation agreements	10
2	Description	11
2.1	Short description	11
2.2	Intended use	11
2.3	Typeplate (North America, Terra AC Wx-Px-xxxxx)	11
2.4	Working principle.....	12
2.5	Overview	13
2.5.1	Overview of the system	13
2.5.2	Overview of the EVSE, outside	13
2.6	Options.....	15
2.6.1	Display	15
2.6.2	EV charge cable, Type 1 (North America, Terra AC Wx-Px-xxxxx).....	15
2.6.3	3G/4G Communication	15
2.6.4	Load management	15
2.7	Control elements	16
	LED indicators.....	16
2.8	TerraConfig app to do the commissioning	17
2.9	Description of the display screens (option)	17
2.9.1	Boot screen	17
2.9.2	Standby/Idle screen	18
2.9.3	Authorization screen.....	18
2.9.4	Preparing to charge screen	19
2.9.5	Charging screen	19
2.9.6	Charging completed screen	20
2.9.7	Fault detected screen.....	20

3	Safety	22
3.1	Liability	22
3.2	Required qualifications for the installation engineer	22
3.3	Personal protective equipment.....	22
3.4	FCC compliance statement	23
3.5	Industry Canada compliance statement.....	23
3.6	General safety instructions.....	23
3.7	Signs on the EVSE	24
3.8	Discard the EVSE or parts of the EVSE.....	25
3.9	Safety instructions for earthing	25
3.10	Special safety instructions(North America, TerraACWx- Px-xxxxx).....	25
3.10.1	Additional important safety instructions.....	25
4	Installation	27
4.1	General installation procedure	27
4.2	Unpack the EVSE	27
5	Site preparation	28
5.1	Select the site	28
5.2	Prepare the site(North America, TerraACWx-Px-xxxxx)	28
5.3	Tools Required for Installation	28
6	Mechanical installation.....	29
6.1	General mechanical installation procedure	29
6.2	Prepare the holes for the mounting screws	29
6.3	Move the socket.....	30
6.4	Install the upper mounting screws	30
7	Electrical installation	31
7.1	General electrical installation procedure	31
7.2	Insert the AC input cable	31
7.2.1	Install the cold-pressed terminal for PE.....	31
7.2.2	Install the lugs or cold-pressed terminal for L1,L2	32
(1)	Lugs	32
(2)	Cold-pressed terminal.....	32
7.2.3	Insert the AC input cable	33
7.3	Connect the AC input cable	34
7.4	Communication connections.....	34
7.4.1	Insert the Ethernet cable	34
7.4.2	Connect the Ethernet cable.....	35
7.4.3	Insert the wires for the smart meter communication	35
7.4.4	Connect the wires for the smart meter communication	36
7.4.5	Insert the Nano-M2M SIM card	36
8	Commissioning.....	37

8.1	General commissioning procedure	37
8.2	Energize the EVSE	38
8.3	Set up the EVSE	38

9 Troubleshooting 39

9.1	Troubleshooting procedure	39
9.2	Troubleshooting table.....	39
9.3	De-energize the EVSE	41

10 Technical data 42

10.1	EVSE Type	42
10.2	General specifications	43
10.3	Ambient conditions	44
10.4	Mass	44
10.5	Protective device compliance	44
10.5.1	Protective device compliance (North America, Terra AC Wx-Px- xxxxx).....	44
10.6	Parts included in the delivery	45
10.7	Requirements for the wall	45
10.8	Noise level	45
10.9	Dimensions	48
10.9.1	AC input with EV charge cable	48
10.9.2	Space requirements for installation	49
10.10	AC input specifications	49
10.10.1	General specifications	49
10.10.2	AC input specifications	49
10.11	General logic interface specifications	50
10.12	Cable specifications	50
10.12.1	AC input cable	50
10.12.2	Ethernet cable specifications	51
10.12.3	RS485 cable specifications	51
10.12.4	Dry contacts input	51
10.12.5	Dry contacts output.....	52
10.12.6	EV charge cable specifications	52
10.13	AC output specifications	52
10.13.1	AC output specifications	52
10.14	Torque specifications	53

1 About this document

1.1 Function of this document

The document is only applicable for this EVSE (Terra AC), including the variants and options listed in section 11.1. The EVSE from here on in the document is referred to as the EVSE.

The document gives the information that is necessary to do these tasks:

- 1 Installation
- 2 Commissioning

1.2 Target group

The document is intended for qualified installation engineers.
For a description of the required qualifications, refer to section 3.2.

1.3 Revision history

Version	Date	Description
001	October 2021	Initial version

1.4 Language

The original instructions of this document are in English (EN-US). All other language versions are translations of the original instructions.

1.5 Illustrations

It is not always possible to show the configuration of your EVSE. The illustrations in this document show a typical setup. They are for instruction and description only.

1.6 Units of measurement

SI units of measurement (metric system) are used. If necessary, the document shows other units between parentheses () or in separate columns in tables.

1.7 Typographical conventions

The lists and steps in procedures have numbers (123) or letters (abc) if the sequence is important.

1.8 How to use this document











Make sure that you know the structure and contents of this document.

Read the safety chapter and make sure that you know all the instructions.

Do the steps in the procedures fully and in the correct sequence.

Keep the document in a safe location that you can easily access. This document is a part of the EVSE.





1.9 General symbols and signal words

Signal word	Description	Symbol
Danger	If you do not obey the instruction, this can cause injury or death	Refer to section 1.10
Warning	If you do not obey the instruction, this can cause injury.	Refer to section 1.10.
Caution	If you do not obey the instruction, this can cause damage to the EVSE or to property	
Note	A note gives more data, to make it easier to do the steps, for example.	
-	Information about the condition of the EVSE before you start the procedure	
-	Requirements for personnel for a procedure.	
-	General safety instructions for a procedure.	
-	Information about spare parts that are necessary for a procedure.	
-	Information about support equipment that is necessary for a procedure.	
-	Information about supplies (consumables) that are necessary for a procedure.	
-	Make sure that the power supply to the EVSE is disconnected.	
-	Electrotechnical expertise is required, according to the local rules	
-	Alternating current supply	



Note: It is possible that not all symbols or signal words are present in this document.

1.10 Special symbols for warnings and dangers

Symbol	Risk type
	General risk
	Hazardous voltage that gives risk of electrocution
	Risk of pinching or crushing of body parts
	Rotating parts that can cause a risk of entrapment



Note: It is possible that not all symbols are present in this document.

1.11 Related documents

Document name	Target group
Product data sheet	All target groups
Installation manual	Qualified installation engineer
User manual	Owner
Declaration of conformity (CE)	All target groups

You can find all related documents here: <https://new.abb.com/ev-charging/terra-ac-wallbox>.

1.12 Manufacturer and contact data

Manufacturer

ABB EV Infrastructure
 George Hintzenweg 81
 3068 AX,
 Rotterdam The
 Netherlands

Contact data

The local representative of the manufacturer can give you support on the EVSE. You can find the contact data here: <https://new.abb.com/>

1.13 Abbreviations

Abbreviation	Definition
AC	Alternating current
CAN	Controller area network
CCS	Combined charging system
CHAdemo	Charge de Move
CPU	Central processing unit
DC	Direct current
EMC	Electromagnetic compatibility
EV	Electric vehicle
EVSE	Electric vehicle supply equipment
MID	Measuring Instruments Directive
NFC	Near field communication
NoBo	Notified body
OCPP	Open charge point protocol
PE	Protective earth
PPE	Personal protective equipment
RFID	Radio-frequency identification



Note: It is possible that not all abbreviations are present in this document.

1.14 Terminology

Term	Definition
Network operating center of the manufacturer	Facility of the manufacturer to do a remote check on the correct operation of the EVSE
Cabinet	Enclosure of the EVSE, including the components on the inside

Term	Definition
Contractor	Third party that the owner or site operator hires to do engineering, civil and electrical installation work
Grid provider	Company that is responsible for the transport and distribution of electricity
Local rules	All rules that apply to the EVSE during the entire lifecycle of the EVSE. The local rules also include the national laws and regulations.
Open charge point protocol	Open standard for communication with charge stations
Owner	Legal owner of the EVSE
Site operator	Entity that is responsible for the day-to-day control of the EVSE. The site operator does not have to be the owner.
User	Owner of an EV, who uses the EVSE to charge the EV



Note: It is possible that not all terms are present in this document.

1.15 Orientation agreements

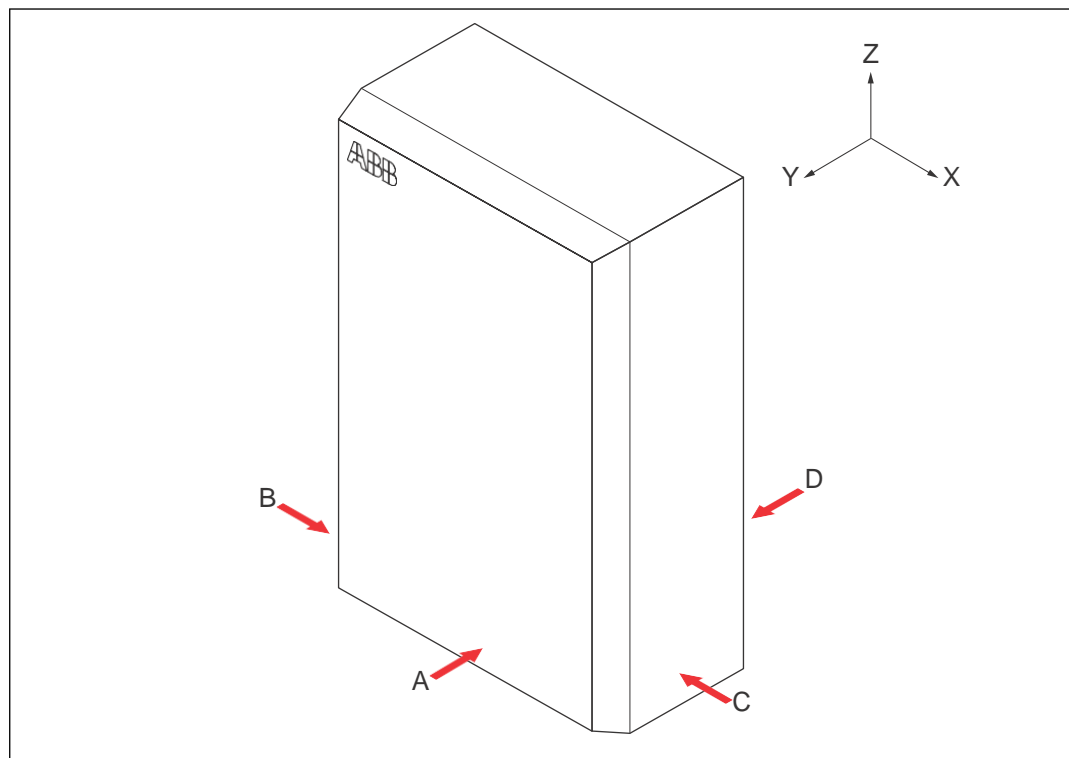

- | | | | |
|---|--|---|--|
| A | Front side: face forward to the EVSE during normal use | X | X-direction (positive is to the right) |
| B | Left side | Y | Y-direction (positive is rearward) |
| C | Rightside | Z | Z-direction (positive is upward) |
| D | Rear side | | |

2 Description

2.1 Short description

The EVSE (Terra AC) is an AC charging station that you can use to supply electricity to an EV. The Terra AC offers tailor-made, intelligent and network charging solutions for your company or home. The EVSE can connect to the internet via GSM, WiFi or LAN.

2.2 Intended use

The EVSE is intended for the AC charging of EVs. The EVSE is intended for indoor or outdoor use.

The technical data of the EVSE must comply with the properties of the electrical grid, the ambient conditions and the EV. Refer to chapter 11.

Only use the EVSE with accessories that the manufacturer provides or that obey the local rules.

The EVSE AC input is intended for a hardwired installation that complies with the applicable national regulations.



Danger:

General risk

- 1 If you use the EVSE in any other way than described in the related documents, you can cause death, injury and damage to property.
- 2 Use the EVSE only as intended.

2.3 Type plate (North America, Terra AC Wx-Px-xxxxx)

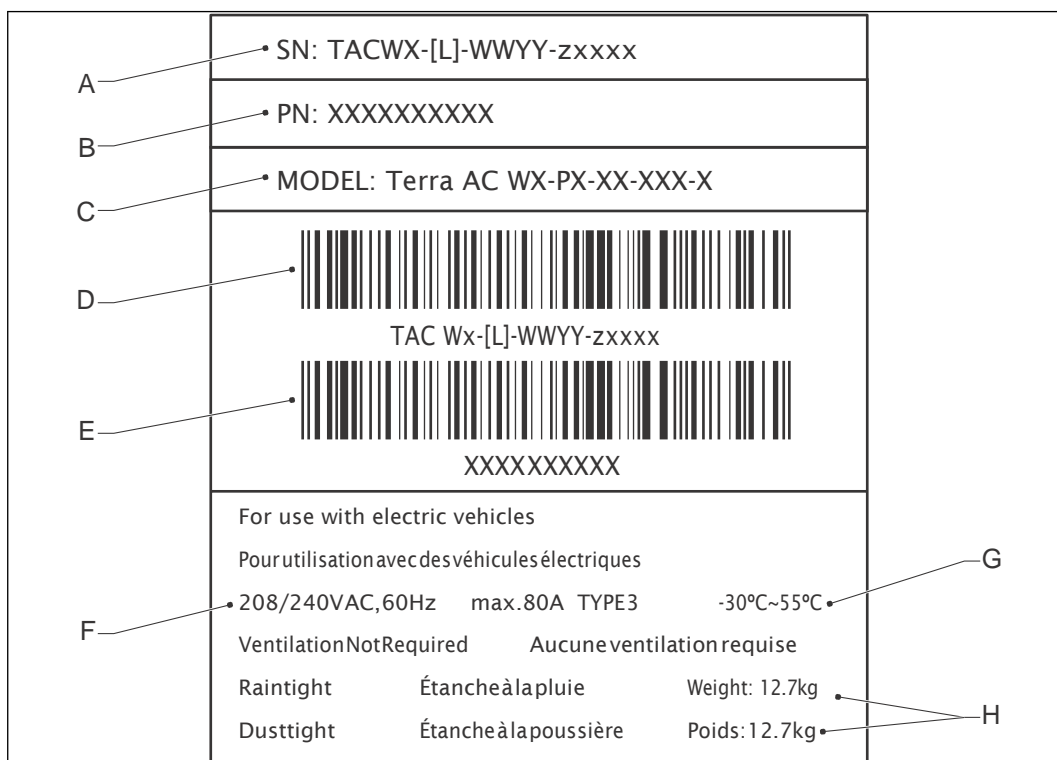

Description

A	Serial number	E	Barcode with the part number of the EVSE
B	Part number of the EVSE	F	Power rating of the EVSE
C	Product model number	G	Ambient temperature
D	Barcode with the serial number of the EVSE	H	Mass of the EVSE



Note: The data in the illustration is only an example. Find the type plate on your EVSE to see the applicable data. Refer to section 2.6.2.

2.4 Working principle

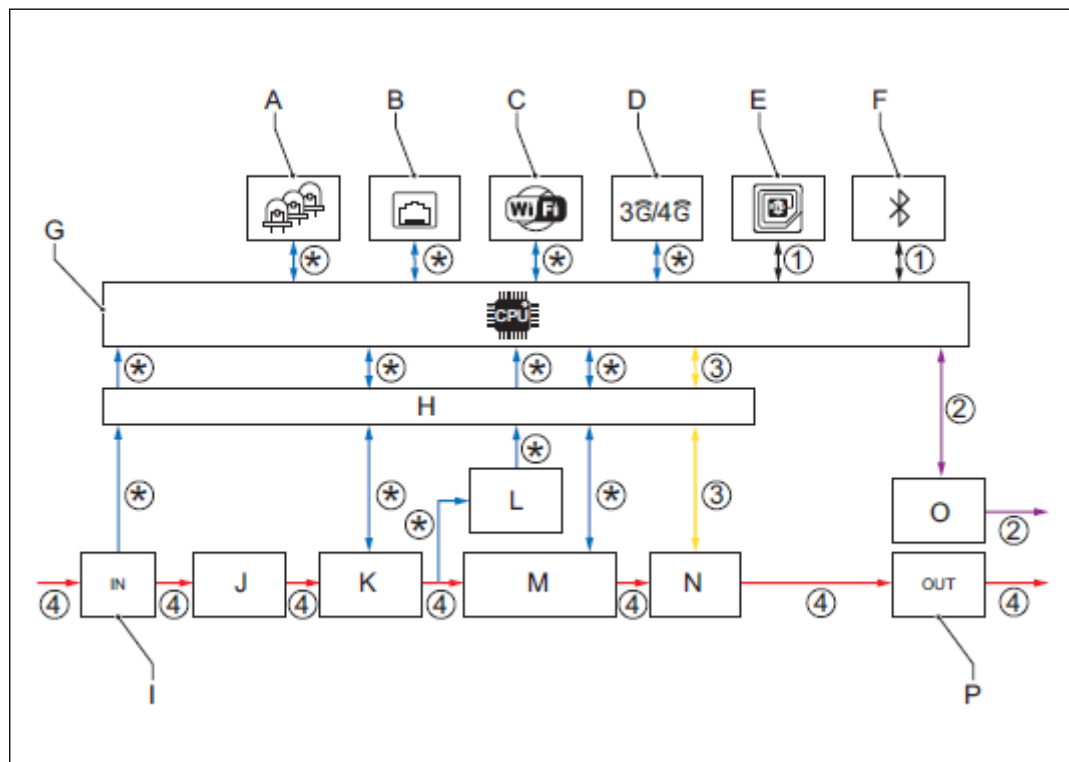

A	LEDs	I	AC/DC power supply
B	Ethernet	J	AC input
C	WiFi	K	Surge protection
D	3G/4G	L	Earth(ground) fault protection
E	RFID	M	AC input metering
F	Bluetooth	N	AC isolation relay
G	CPU system	O	Control pilot
H	Isolation	P	AC output

1. The user initiates a charge session request (black lines).
2. The EVSE verifies the status of the EV (purple lines).
3. The EVSE goes on and AC power goes to the EV (yellow lines).
4. The charge session starts. AC power flows from the power grid to the EV (red lines).
5. The electrical interfaces of the EVSE communicate with the on-board computer (blue lines).

(*): Connections between parts of the EVSE and the CPU system. The arrow shows the direction of the input and output signals.

2.5
2.5.1

Overview
Overview of the system

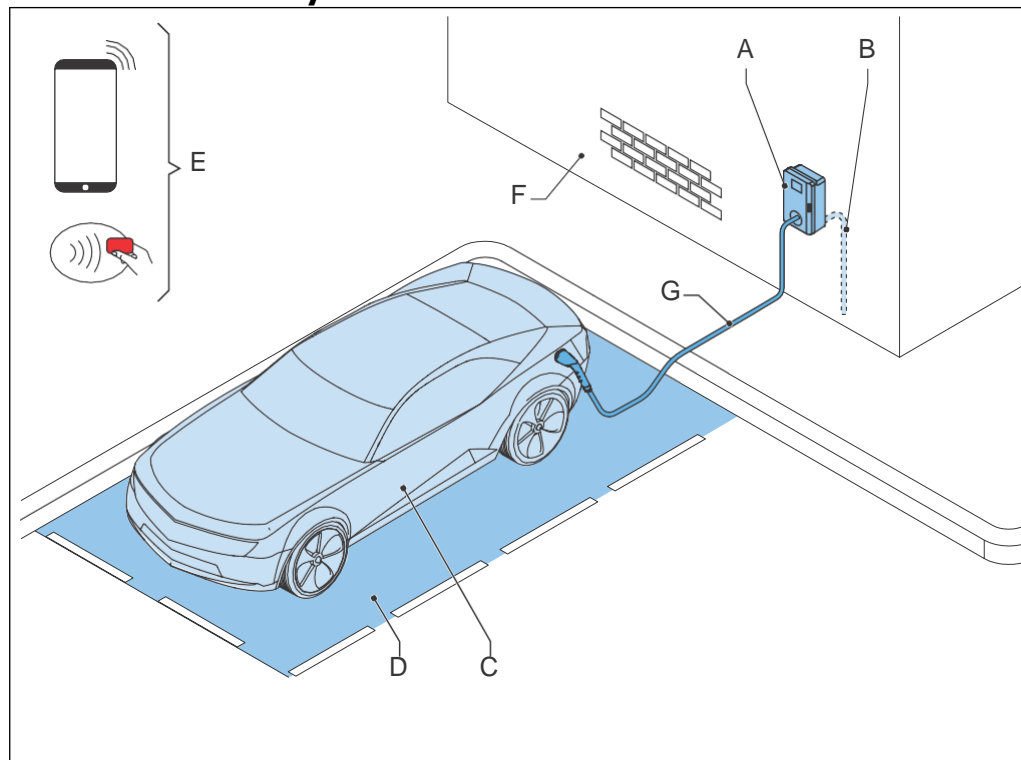

- | | | | |
|---|---------------|---|----------------------------------|
| A | EVSE | E | RFID card or smartphone |
| B | AC grid input | F | Structure to install the EVSE on |
| C | EV | G | EV charge cable |
| D | Parking space | | |

Part	Function
EVSE	Refer to section 2.2.
Structure	To install the EVSE on and to keep the EVSE in position.
AC grid input	To supply the electricity to the EVSE
EV charge cable	To conduct the charge from the EVSE to the EV
EV	The EV of which the batteries need to be charged
Parking space	Location for the EV during the charge session
RFID card or smartphone	To authorize the user to use the EVSE

2.5.2

Overview of the EVSE, outside



Note: The illustration shows the EVSE model without a display.

Description

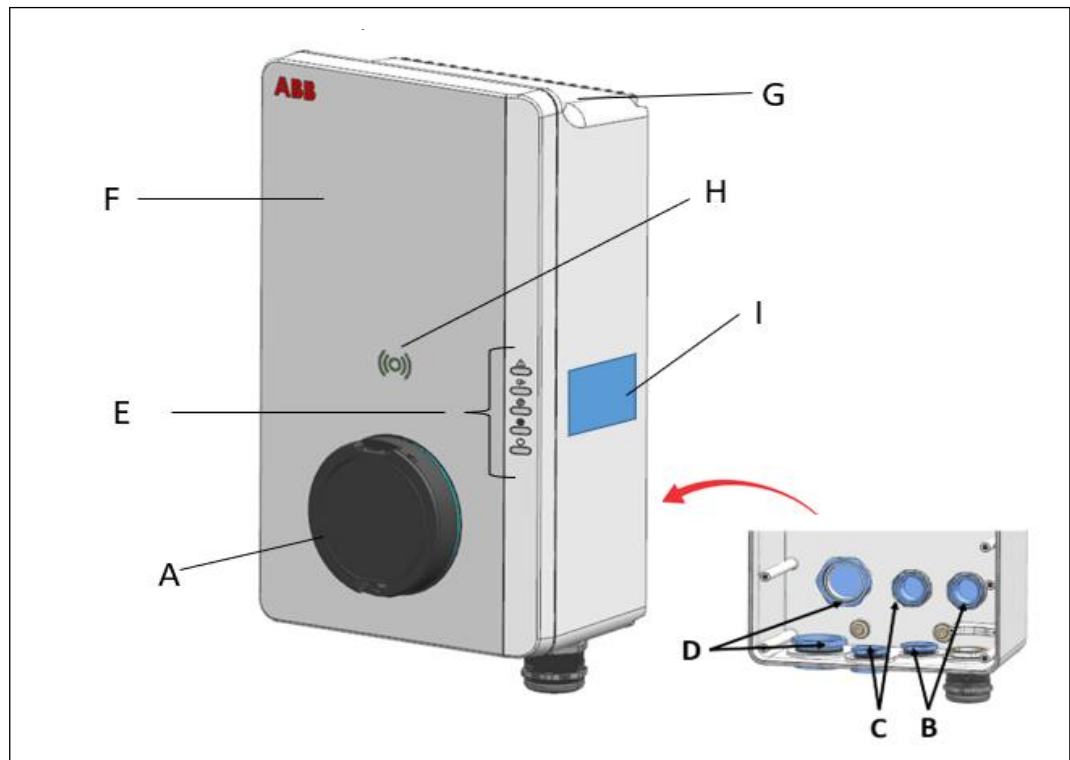

- | | | | |
|---|--|---|---------------|
| A | Socket for the EV charge cable | F | Cabinet cover |
| B | Openings for the smart meter connections | G | Enclosure |
| C | Openings for the Ethernet cable | H | RFID reader |
| D | Opening for the AC input cable | I | Type plate |
| E | LED indicators | | |

Part	Function
Socket for the EV charge cable	To hang the EV charge cable
Openings	Openings for the cables that go into the EVSE
LED indicators	To show the status of the EVSE and the charge session. Refer to section 2.8.1.
Cabinet cover	To prevent a user to access the installation and maintenance parts of the EVSE
Enclosure	To reduce the accessibility of unqualified persons to the inside of the EVSE
RFID reader	To authorize the start or stop of a charging session with an RFID card
Type plate	To show the identification data of the EVSE. Refer to section 2.3.

2.6 Options

2.6.1 Display

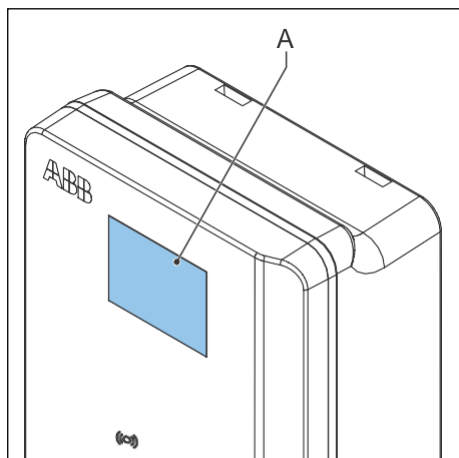

A Display

For more data about the display, refer to section 2.10.

2.6.2 EV charge cable, Type 1 (North America, Terra AC Wx-Px-xxxxx)

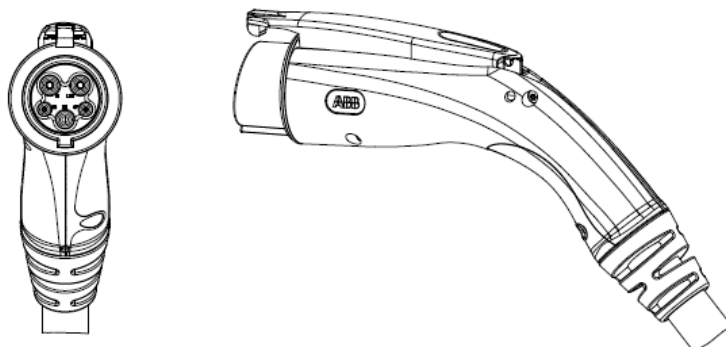

2.6.3 3G/4G Communication

You can connect to a 3G/4G network.

2.6.4 Load management

Load management makes sure that the available capacity of the building or home is not exceeded. A number of devices share a grid connection, that has a maximum capacity. The total power demand of the devices that use the grid connection must not exceed the grid capacity.

The load management feature prevents that the system exceeds the grid capacity and prevents damage of the fuses. At times when the current demand is high, the EVSE decreases the output of current. The current will increase again when there is availability on the grid.

Also, the load management feature makes sure that the available load is optimally shared.

2.7 Control elements LED indicators

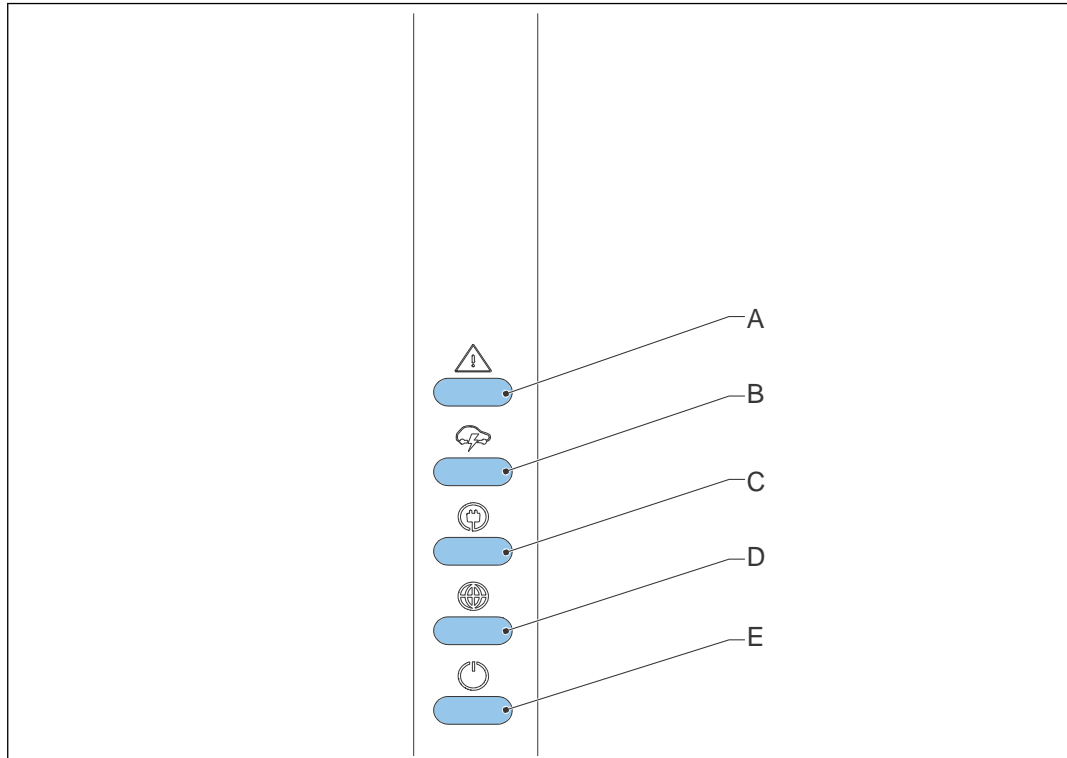

- A Error LED
- B Charging LED
- C Cable and car detection, and car authorization LED
- D Internet connection LED
- E EVSE on/off LED

Table 1: Error LED

Status of the LED	Status of the EVSE
On	Error
Off	No error

Table 2: Charging LED

Status of the LED	Status of the EVSE
On	EV is fully charged or has stopped charging
Off	Not charging
Flashing	Charging

Table 3: Cable and car detection, and car authorization LED

Status of the LED	Status of the EVSE
On	A car is connected. The connection is authorized.
Off	No car connected.
Flashing	A car is connected, waiting for authorization.

Table 4: Internet connection LED

Status of the LED	Status of the EVSE
On	Connected to the internet
Off	Not connected to the internet
Flashing	The internet connection is set up.

Table 5: EVSE on/off LED

Status of the LED	Status of the EVSE
On	The EVSE is on
Off	The EVSE is off
Flashing	The EVSE is in setup.

2.8 TerraConfig app to do the commissioning

The *TerraConfig* app is available on the *Apple Store* and on the *Google Play Store*. The app is necessary to do the commissioning.

2.9 Description of the display screens (option)

2.9.1 Boot screen

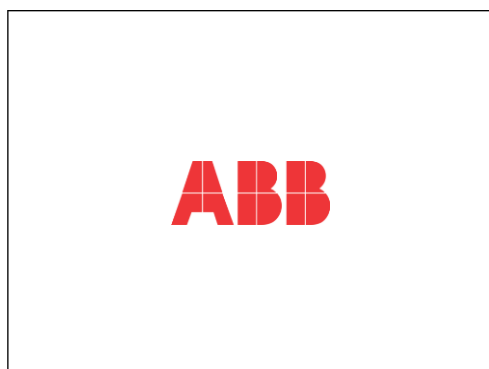

During the startup of the EVSE, the display shows the Boot screen.

2.9.2 Standby/Idle screen

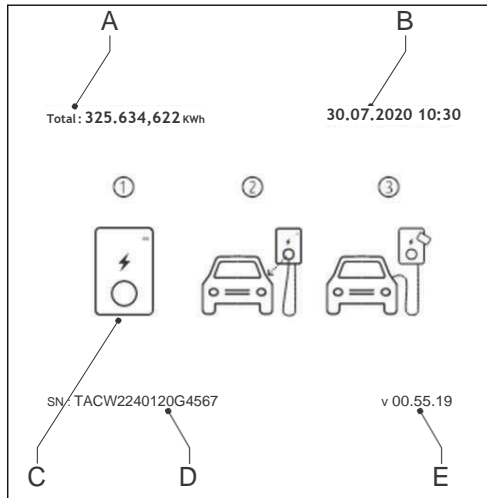

- A Total delivered energy
- B Date
- C Guide
- D Serial number
- E Firmware version (MID certified)

The display shows the Standby/Idle screen when the EVSE is in idle status. Then, the EVSE is available for a charge session.

2.9.3 Authorization screen

The display shows different Authorization screens, dependent on the situation.

The display shows this Authorization screen when the EV charge cable is connected to the EV but the charge session is not authorized:

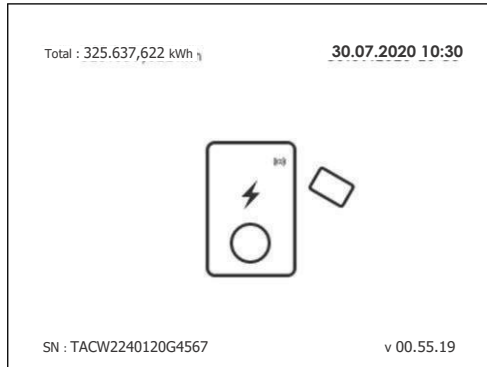

The display shows this Authorization screen when the charge session is authorized but the EV charge cable is not connected to the EV:

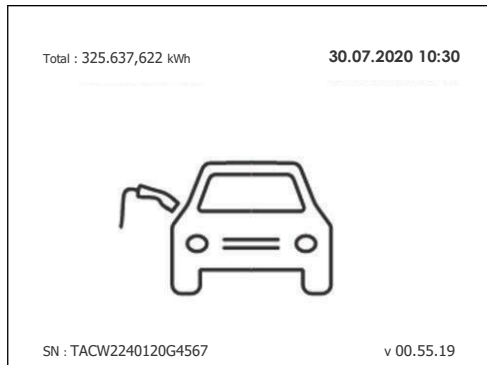

2.9.4 Preparing to charge screen

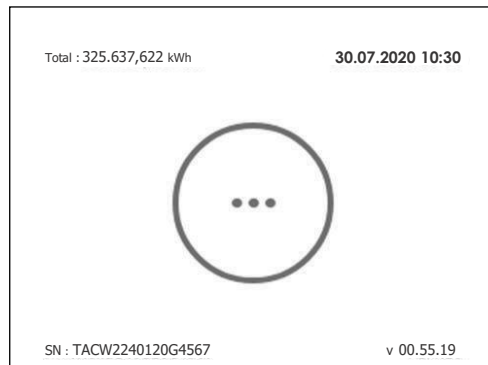

2.9.5 Charging screen

The display shows the Charging screen during the charge session. The display shows this Charging screen for a single phase EVSE:

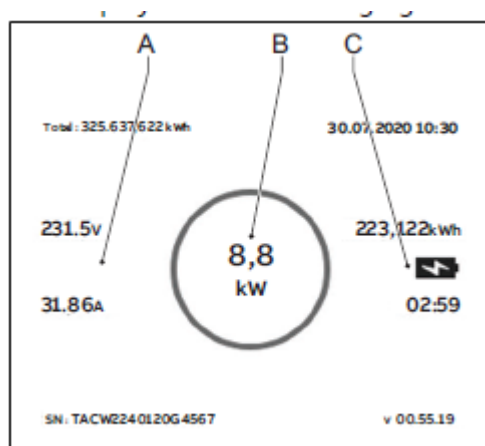

A Real-time voltage and current

B Real-time power

C Energy delivered and duration of the charge session

2.9.6 Charging completed screen

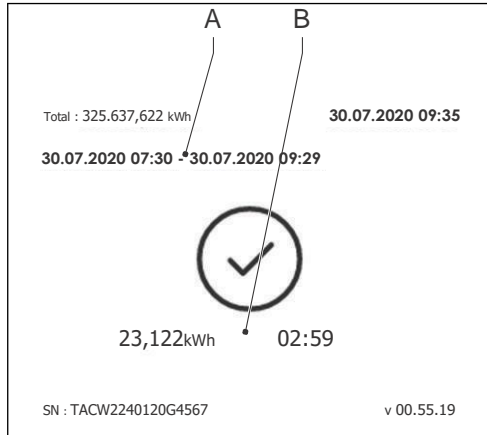

A Start and end time

B Energy delivered and duration of the charge session

2.9.7 Fault detected screen

The display shows different Fault detected screens, dependent on the type of fault. Disconnect the charge cable and connect it again:

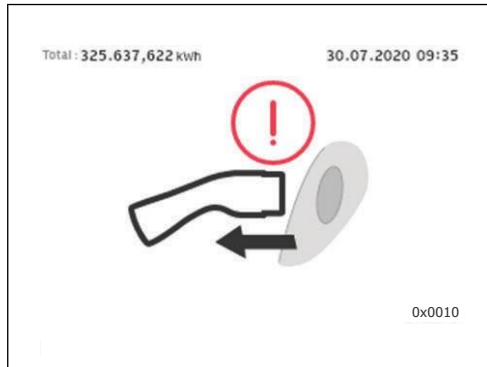

Contact your service provider:

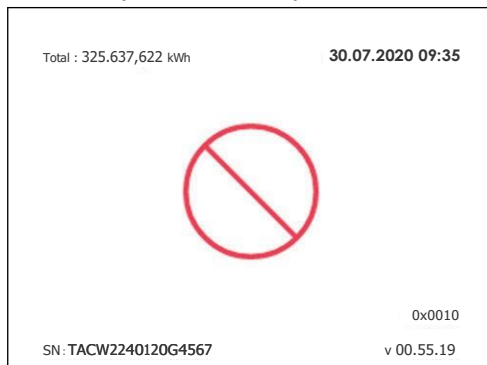

The EV is not ready for the charge session:

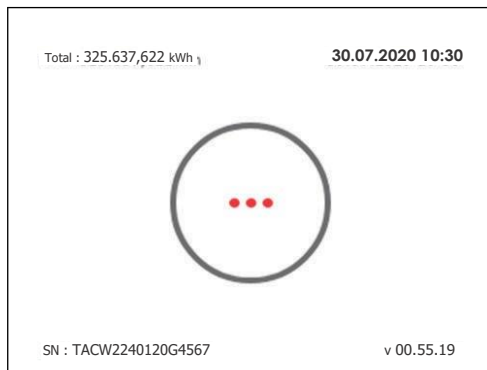

3 Safety

3.1 Liability

The manufacturer is not liable to the purchaser of the EVSE or to third parties for damages, losses, costs or expenses incurred by the purchaser or third parties if any target group mentioned in the related documents does not obey the rules below:

- 1 Obey the instructions in the related documents. Refer to section 1.11.
- 2 Do not misuse or abuse the EVSE.
- 3 Only make changes to the EVSE, if the manufacturer approves in writing of the changes.

This EVSE is designed to be connected to and to communicate information and data via a network interface. It is the sole responsibility of the owner to provide and continuously ensure a secure connection between the EVSE and the network of the owner or any other network.

The owner shall establish and maintain any appropriate measures (such as - but not limited to - the installation of firewalls, application of authentication measures, encryption of data and installation of anti-virus programs) to protect the EVSE, the network, its system and the interface against any kind of security breaches, unauthorized access, interference, intrusion, leakage and/or theft of data or information.



The manufacturer is not liable for damages and/or losses related to such security breaches, any unauthorized access, interference, intrusion, leakage and/or theft of data or information.



3.2 Required qualifications for the installation engineer



- 1 The qualified installation engineer fully knows the EVSE and its safe installation.
- 2 The installation engineer is qualified according to the applicable local rules to do the work.
- 3 The qualified installation engineer obeys all local rules and the instructions in the installation manual.
- 4 It is the responsibility of the owner of the EVSE to make sure that all qualified installation engineers obey the local rules, the installation instructions, and the specifications of the EVSE.

3.3 Personal protective equipment

Symbol	Description
	Protective clothing
	Safety gloves

Symbol	Description
	Safety shoes
	Safety glasses

3.4

FCC compliance statement

Caution: Changes or modifications not expressly approved by the party responsible for compliance could void the user's authority to operate the equipment.

This device complies with Part 15 of the FCC Rules. Operation is subject to the following two conditions:

- (1) This device may not cause harmful interference, and
- (2) This device must accept any interference received, including interference that may cause undesired operation.



Note: This equipment has been tested and found to comply with the limits for a Class B digital device, pursuant to part 15 of the FCC Rules. These limits are designed to provide reasonable protection against harmful interference in a residential installation. This equipment generates, uses and can radiate radio frequency energy and, if not installed and used in accordance with the instructions, may cause harmful interference to radio communications. However, there is no guarantee that interference will not occur in a particular installation. If this equipment does cause harmful interference to radio or television reception, which can be determined by turning the equipment off and on, the user is encouraged to try to correct the interference by one or more of the following measures:

- 1 Reorient or relocate the receiving antenna.
- 2 Increase the separation between the equipment and receiver.
- 3 Connect the equipment into an outlet on a circuit different from that to which the receiver is connected.
- 4 Consult the dealer or an experienced radio/TV technician for help.

3.5

This device complies with Industry Canada licence-exempt RSS standard(s). Operation is subject to the following two conditions:

- (1) this device may not cause interference, and
- (2) this device must accept any interference, including interference that may cause undesired operation of the device.

Le présent appareil est conforme aux CNR d'Industrie Canada applicables aux appareils radioexempts de licence. L'exploitation est autorisée aux deux conditions suivantes :

- (1) l'appareil ne doit pas produire de brouillage, et
- (2) l'utilisateur de l'appareil doit accepter tout brouillage radioélectrique subi, même si le brouillage est susceptible d'en compromettre le fonctionnement.

RF exposure statement

This equipment complies with FCC/IC RSS-102 radiation exposure limits set forth for an uncontrolled environment. This equipment should be installed and operated with minimum distance 20cm between the radiator & your body.

3.6

General safety instructions







- 1 This document, the related documents and the warnings included do not replace your responsibility to use your common sense when you do work on the EVSE.
- 2 Only do the procedures that the related documents show and that

you are qualified for.

- 3 Obey the local rules and the instructions in this manual. If the local rules contradict the instructions in this manual, the local rules will apply.

If and to the extent permitted by law, in case of inconsistency or contradiction, between any requirements or procedure contained in this document and any such local rules, obey the stricter between the requirements and procedures specified in this document and the local rules.

3.7 Signs on the EVSE

Symbol	Risk type
	General risk
	Hazardous voltage that gives risk of electrocution
	Risk of pinching or crushing of body parts
	Rotating parts can cause a risk of entrapment
	PE
	Sign that means that you must read the manual before you install the EVSE
	Waste from electrical and electronic equipment



Note: It is possible that not all symbols are present on the EVSE.

3.8 Discard the EVSE or parts of the EVSE

Incorrect waste handling can have a negative effect on the environment and human health due to potential hazardous substances. With the correct disposal of this product, you contribute to reuse and recycling of materials and protection of the environment.

- 1 Obey the local rules to discard parts, packaging material or the EVSE.
- 2 Discard electrical and electronic equipment separately in compliance with the WEEE - 2012/19/EU Directive on waste of electrical and electronic equipment.
- 3 As the symbol of the crossed out wheeled-bin on your EVSE indicates, do not mix or dispose the EVSE with your household waste, at the end of use. Instead, hand the EVSE over to your local community waste collection point for recycling.
- 4 For more information, contact the Government Waste-Disposal department in your country.

3.9 Safety instructions for earthing

Preliminary requirements



- 1 Make sure that the EVSE is connected to a grounded, metal, permanent wiring system, or an equipment-grounding conductor must be run with the circuit conductors and connected to the equipment grounding terminal or lead on the product.
- 2 Make sure that the connections to the EVSE comply with all applicable local rules.

3.10 Special safety instructions (North America, Terra ACWx-Px-xxxxx)

3.10.1 Additional important safety instructions



Warning: Obey the basic precautions for electric products, including the instructions in this section.



Caution: To reduce the risk of fire, connect this EVSE only to a circuit provided with 100 A maximum branch circuit overcurrent protection in accordance with the National Electrical Code, ANSI/NFPA 70.

- Read all the instructions before you use this EVSE.

Safety



- Make sure that adults supervise this EVSE is when it is used around children.
- Do not put fingers into the EV connector.
- Do not use this product if the flexible power cord or EV charge cable is frayed, has broken insulation, or any other signs of damage.
- Do not use this EVSE if the enclosure or the EV connector is broken, cracked, open, or shows any other indication of damage.
- Install an insulated grounding conductor that is identical in size, insulation material, and thickness to the grounded and ungrounded branch-circuit supply conductors, except that it is green with or without one or more yellow stripes, as part of the branch circuit that supplies the EVSE.
- Connect the grounding connector of the previous bullet point to earth at the EVSE or, when supplied by a separately derived system, at the supply transformer.
- For the AC power input wiring installation, refer to section 10.11.4.
- For the torque requirements for the screws of the terminal block for the AC power, refer to section 10.14.

SAVE THESE INSTRUCTIONS

4 Installation

4.1 General installation procedure

Preliminary requirements

	<ol style="list-style-type: none"> 1. All required permits to agree with the local rules are granted. 2. The AC input cable is available. 		<ul style="list-style-type: none"> • There is no voltage on the AC input cable during the complete installation procedure.
	<ul style="list-style-type: none"> • Tools for installation. Refer to section 11.7. 		

Procedure

1. Unpack the EVSE. Refer to section 4.2.
2. Prepare the site. Refer to chapter 5.
3. Do the mechanical installation. Refer to section 6.1.
4. Do the electrical installation. Refer to section 7.1.
5. Install the cabinet cover.
6. Do the commissioning procedure. Refer to section 8.1.

4.2 Unpack the EVSE

1. Open the box.
2. Remove the EVSE from the box.
3. Remove all packaging material from the EVSE.
4. Discard the packaging material. Refer to section 3.8.
5. Make sure that all parts are delivered according to the order. Refer to the order and section 10.6.
6. Do an inspection of the EVSE and the parts for installation for damage.
7. If you find damage or the parts are not according to the order, contact the local representative of the manufacturer (ABB EV Infrastructure). Refer to section 1.12.



5 Site preparation

5.1 Select the site

1. Find a suitable site on a wall. For the specifications of the wall, refer to section 10.7.
2. Make sure that the correct power supply is available. For the power supply specifications, refer to section 10.10.
3. Obey the space requirements. Refer to section 10.9.2.

5.2 Prepare the site (North America, Terra ACWx-Px-xxxxx)

Preliminary requirements

<input checked="" type="checkbox"/>  <input checked="" type="checkbox"/>  <input type="checkbox"/> 	1. The site must be suitable to install the EVSE. Refer to section 5.2.
--	---

Procedure

1. Make sure that the space and the airflow around the EVSE are sufficient. Refer to section 10.9.2.
2. Make sure that the correct cables are available at the site.
 - AC input cable. Refer to section 10.12.1.
 - RS485 cable. Refer to section 10.12.3.
 - Ethernet cable. Refer to section 10.12.2.

5.3 Tools Required for Installation

Tools	Applicable Models	Supplier Name	Supplier Part#
Security Torx T25 L-Driver	All Product Models	Commercially Available	Commercially Available
Security Torx T20 Drive	All Product Models	Commercially Available	Commercially Available
Wire Cutters	All Product Models	Commercially Available	Commercially Available
Wire Strippers	All Product Models	Commercially Available	Commercially Available
Channellock Pliers	All Product Models	Commercially Available	Commercially Available
Torque Wrench	All Product Models	Commercially Available	Commercially Available
Drill	All Product Models	Commercially Available	Commercially Available
Drill Bits	All Product Models	Commercially Available	Commercially Available
Slotted Screwdriver	All Product Models	Commercially Available	Commercially Available
P2 Phillips Screwdriver	All Product Models	Commercially Available	Commercially Available
P3 Phillips Screwdriver	All Product Models	Commercially Available	Commercially Available
Crimpers, 8 AWG	All Product Models	Commercially Available	Commercially Available
Crimpers, 1/0 - 8 AWG(optional)	All Product Models	Commercially Available	Commercially Available

6 Mechanical installation

6.1 General mechanical installation procedure





Note: The mounting screws and plugs that are included in the delivery are serviceable for a brick wall. If you want to mount the EVSE on a different type of wall, contact your local representative of the manufacturer (ABB EV Infrastructure).

1. Prepare the holes for the mounting screws. Refer to section 6.2.
2. Move the socket. Refer to section 6.3.
3. Install the EVSE on the site. Refer to section 6.4.

6.2 Prepare the holes for the mounting screws

Preliminary requirements

	<ul style="list-style-type: none"> • Spirit level • Drill 		<ul style="list-style-type: none"> • Installation template. Refer to section 10.6. • Plugs for the mounting holes. Refer to section 10.6
---	---	---	--

Procedure

1. Hold the installation template (A) against the wall.
2. Make sure that the installation is level. Use the spirit level.
3. Mark the location for the mounting holes (B).
4. Drill the mounting holes (B).



Note: For the diameter of the holes, refer to the plugs for the upper and lower mounting holes.

5. Insert the plugs for the mounting holes (C) in the mounting holes.

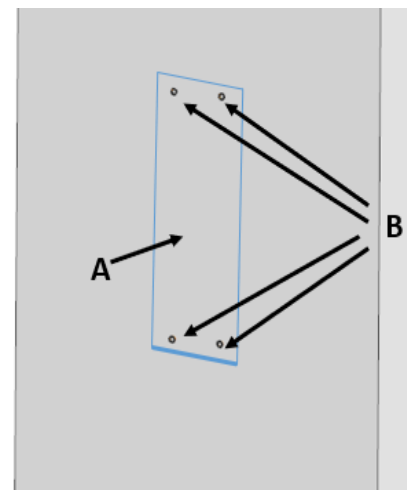
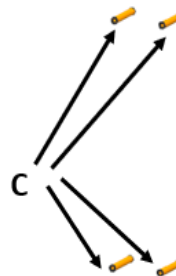

6.3 Move the socket

Preliminary requirements

	<p>1. The plugs for the mounting screws are installed.</p>		<ul style="list-style-type: none"> Screwdriver
--	--	--	---

Procedure

1. Remove 2 screws and remove the front cover.
2. Remove 11 screws and remove the maintenance door.
3. Remove the screw(A) on the left side of socket.
4. Move the socket away.

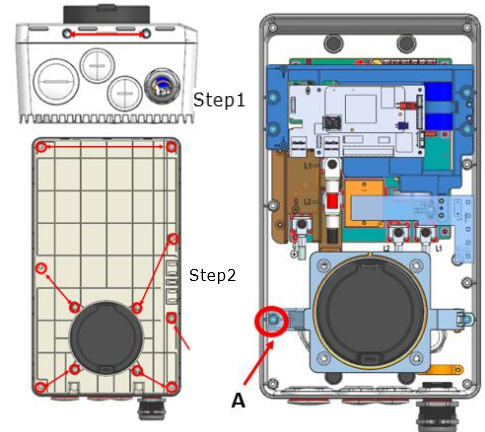

6.4 Install the upper mounting screws

Preliminary requirements

	<p>1. The plugs for the upper and lower mounting screws are installed.</p>		<ul style="list-style-type: none"> Mounting screws. Refer to section 10.6.
--	--	--	---

Procedure

1. Install the mounting screws (A) through the holes (B) in the charger.
2. Lock the screws in the plugs. For the specification, refer to section 10.7.

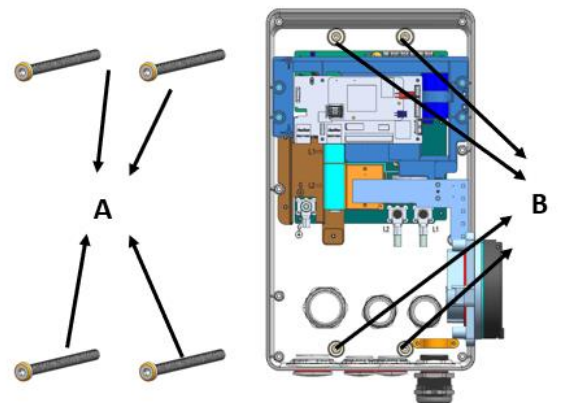

7 Electrical installation

7.1 General electrical installation procedure

Preliminary requirements



Procedure

1. Install the AC input cable.
 - Insert the AC input cable. Refer to section 7.2.
 - Connect the AC input cable. Refer to section 7.3.
2. Install the Ethernet cable.
 - Insert the Ethernet cable. Refer to section 7.4.1.
 - Connect the Ethernet cable. Refer to section 7.4.2.
3. If necessary, install the cables for smart meter communication.
 - Insert the cables for smart meter communication. Refer to section 7.4.3.
 - Connect the cables for smart meter communication. Refer to section 7.4.4.
4. If you want to use the internet, insert the Nano-M2M SIM card. Refer to section 7.4.5.
5. If necessary, replace the EV charge cable. Refer to section 7.5.

7.2 Insert the AC input cable

7.2.1 Install the cold-pressed terminal for PE

Preliminary requirements

	• Crimping Tool		• AC input cable (1 phase)
	• Cold-pressed terminal for PE. Refer to section 10.6.		

Procedure

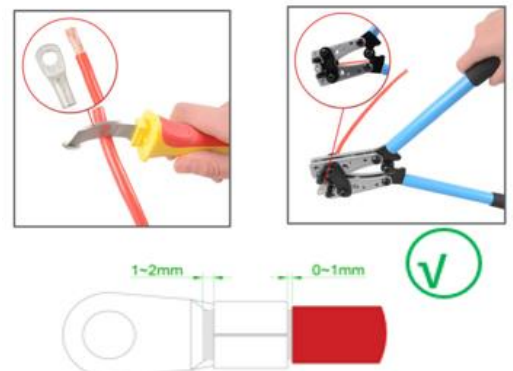

1. Strip the wires. For the specification, refer to section 10.12.1.
2. Insert the cable into the cold-pressed terminal to its full insertion length. Crimp the cold-pressed terminal with the correct jaws.
3. Finished.



7.2.2 Install the lugs or cold-pressed terminal for L1,L2

(1) Lugs

Preliminary requirements

	<ul style="list-style-type: none"> • Torque Screwdriver 		<ul style="list-style-type: none"> • AC input cable (1 phase)
	<ul style="list-style-type: none"> • Lugs. Refer to section 10.6. 		<ul style="list-style-type: none"> •

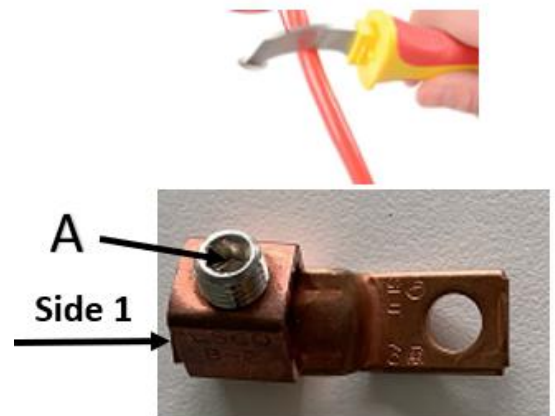

Procedure

1. Loosen the screws(A)
2. Strip the wires. For the specification, refer to section 10.12.1..
3. Insert the wire in the side 1 of lugs.
4. Tighten the screws(A) to the correct torque. For the specification, refer to section 10.14



(2) Cold-pressed terminal

Preliminary requirements

	<ul style="list-style-type: none"> • Crimping Tool(2AWG) 		<ul style="list-style-type: none"> • AC input cable (1 phase)
	<ul style="list-style-type: none"> • Cold-pressed terminal for L1,L2. Refer to section 10.6. 		<ul style="list-style-type: none"> •

Procedure

1. Strip the wires. For the specification, refer to section 10.12.1.
2. Insert the cable into the cable lug or connector to its full insertion length. Crimp the cable lug or connector with the correct jaws.
3. Finished.

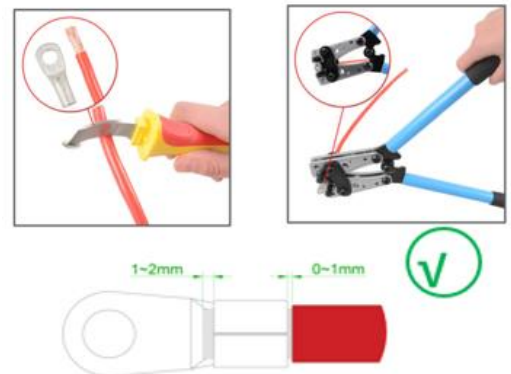

7.2.3 Insert the AC input cable

Preliminary requirements

	<ul style="list-style-type: none"> Screwdriver 		<ul style="list-style-type: none"> AC input cable
---	---	---	--

Procedure

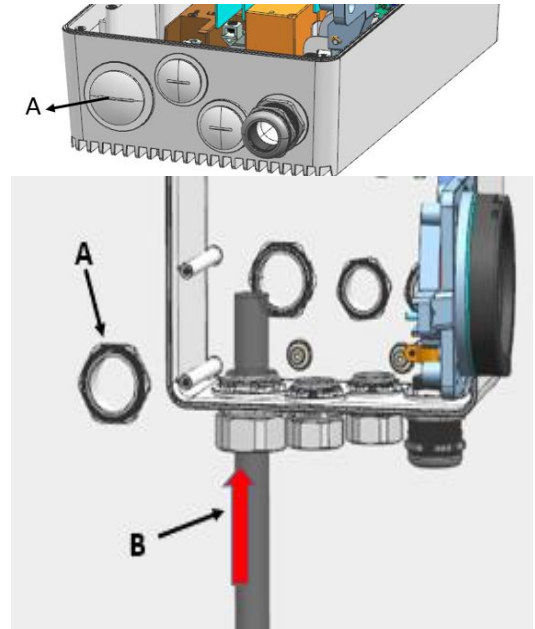

1. Remove the grommet (A) from the EVSE.
2. Install the conduit.
3. Strip the wires. For the specification, refer to section 10.13.
4. Put the AC input cable (B) through the inlet hole.



All Specifications are Per Charging Station or Port				
Max. Output (Charging) Current	Typical Circuit Breaker (CB) ³	Typical Wire Specs	Typical Conduit Size	Notes / Assumptions
12A	15A	Two #12AWG Wires (Line) One #12AWG Wire (Ground)	1"	≤150FT. One-Way Distance. ≤3% Voltage Drop
16A	20A	Two #10AWG Wires (Line) One #12AWG Wire (Ground)	1"	≤150FT. One-Way Distance. ≤3% Voltage Drop
24A	30A	Two #8AWG Wires (Line) One #10AWG Wire (Ground)	1"	≤150FT. One-Way Distance. ≤3% Voltage Drop
32A	40A	Two #8AWG Wires (Line) One #10AWG Wire (Ground)	1"	≤150FT. One-Way Distance. ≤3% Voltage Drop
40A	50A	Two #6AWG Wires (Line) One #8AWG Wire (Ground)	1"	≤150FT. One-Way Distance. ≤3% Voltage Drop
64A	80A	Two #4AWG Wires (Line) One #8AWG Wire (Ground)	1"	≤150FT. One-Way Distance. ≤3% Voltage Drop
72A	90A	Two #3AWG Wires (Line) One #8AWG Wire (Ground)	1"	≤150FT. One-Way Distance. ≤3% Voltage Drop
80A	100A	Two #2AWG Wires (Line) One #8AWG Wire (Ground)	1"	≤150FT. One-Way Distance. ≤3% Voltage Drop

7.3 Connect the AC input cable

Preliminary requirements

	<ul style="list-style-type: none"> • Torque screwdriver 		<ul style="list-style-type: none"> • AC input cable (1 phase)
---	--	--	--

Procedure

4. Connect the below wires:
 1. Earthing (grounding) wire (A)
 2. L2 AC input wire (B)
 3. L1 AC input wire (C)
5. Tighten the screws(D) to the correct torque. For the specification, refer to section 10.14.
6. Install the protect cover(F).

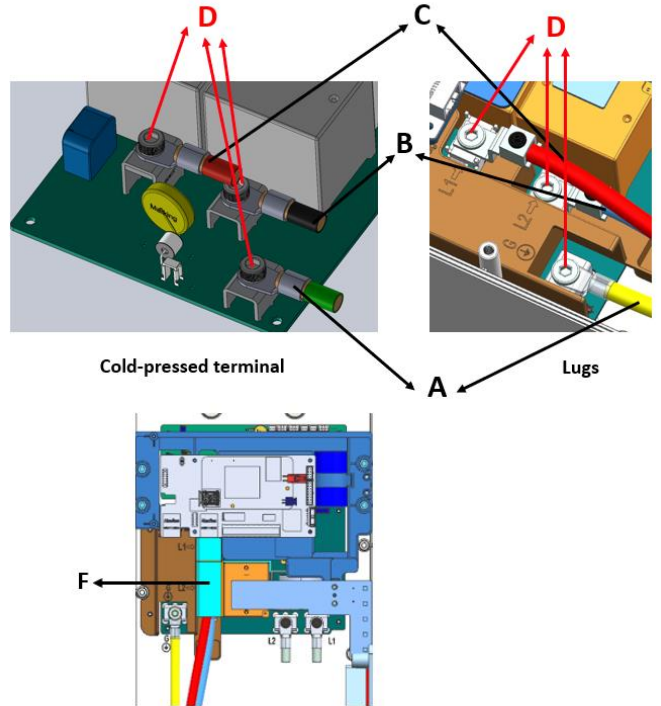

7.4 Communication connections

7.4.1 Insert the Ethernet cable

Preliminary requirements

	<ol style="list-style-type: none"> 1. The cabinet cover is removed. 2. The maintenance cover is removed.
---	--

Procedure

1. Remove the grommet (A) from the EVSE.
2. Install the conduit.
3. Put the Ethernet cable (B) through the cable inlet hole.

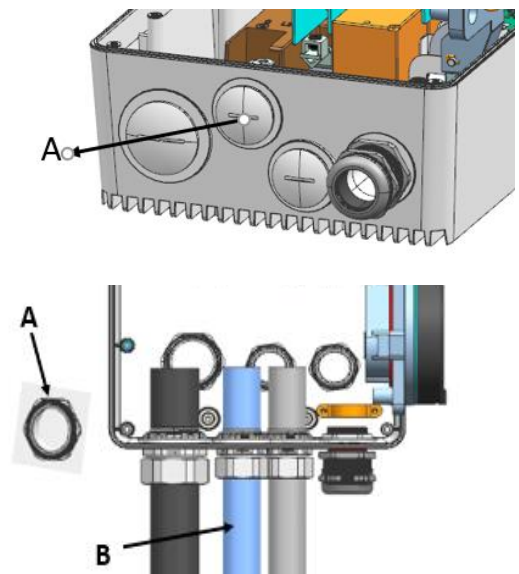

7.4.2 Connect the Ethernet cable

Preliminary requirements

<input checked="" type="checkbox"/> <input checked="" type="checkbox"/> <input type="checkbox"/>	1. The Ethernet cable is inserted. Refer to section 7.4.1.
--	--

If your EVSE has two Ethernet connections, it is possible to connect multiple EVSEs in a chain. Only the first EVSE is connected to the PC, router or gateway. Only the Ethernet connection is shared, there is no communication between the EVSEs.

Procedure

1. Put the RJ45 plug (A) of the Ethernet cable in the primary Ethernet RJ45 socket (B).
2. Connect the Ethernet cable either to a PC, router, or gateway or to the previous EVSE in a chain (C).
3. If you connect EVSEs in a chain, put the RJ45 plug of Ethernet cable to the next EVSE (D) in the secondary Ethernet RJ45 socket (E).

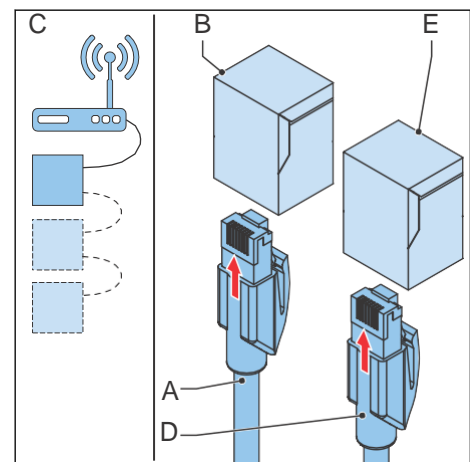

7.4.3

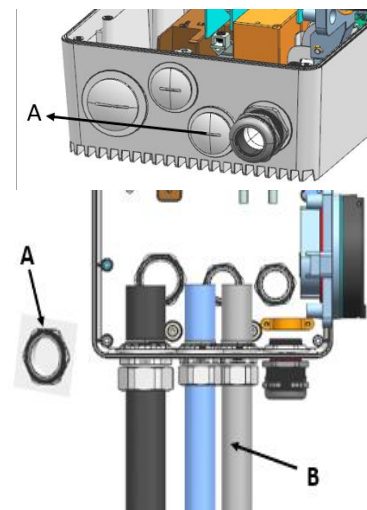

Insert the wires for the smart meter communication

1. Remove the grommet (A) from the EVSE.
2. Install the conduit.
3. If necessary, strip the cable to the correct length. Refer to section 10.12.3.
4. Put the cable (B) through the inlet hole.



7.4.4 Connect the wires for the smart meter communication

Connect the smart meter with ModBus RTU (RS485) to the EVSE.
Preliminary requirements

	<ul style="list-style-type: none">• Slotted screwdriver		<ul style="list-style-type: none">• Smart meter with ModBus RTU interface• Wire for RS485. Refer to section 10.12.3. Obey the local rules for the correct wire insulation rating.
---	---	--	--

Procedure

1. Remove the plug (A) of the terminal block (B) from the terminal block (B) of the smart meter connection.
2. Connect the wires:
 - a. Connect the positive wire (C).
 - b. Connect the negative wire (D).
 - c. If the smart meter has an earthing wire, connect the earthing wire (E).
3. Tighten the screws to the correct torque. For the specification, refer to section 10.14.
4. Install the plug on the terminal block.

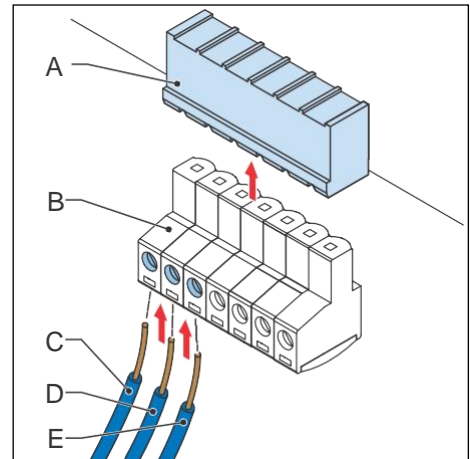

7.4.5 Insert the Nano-M2M SIM card

Preliminary requirements

	<ul style="list-style-type: none">• A Nano-M2M SIM card from the provider of the mobile network. Refer to section 10.11.
---	--

Procedure

1. Insert the Nano-M2M SIM card (A) into the socket (B). Make sure that the position of the connection points is correct.

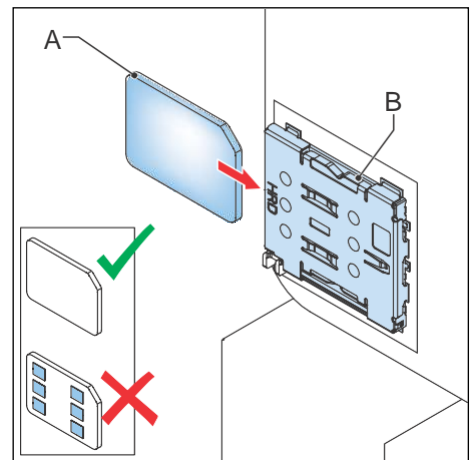

8 Commissioning

8.1 General commissioning procedure

Preliminary requirements

	<ul style="list-style-type: none">• Mobile device
---	---



Warning: Only use this commissioning procedure for domestic use of the EVSE and commissioning with the *TerraConfig* app. For all other methods of commissioning, do not do the commissioning. Contact your local representative of the manufacturer. Refer to section 1.12.

Procedure

Commissioning

1. Download the *TerraConfig* app.
 - For an Android OS mobile device, go to Google Play Store.
 - For an iOS mobile device, go to Apple Store.
2. Energize the EVSE. Refer to section 8.2.
3. Set up the EVSE. Refer to section 8.3.

8.2 Energize the EVSE

1. Close the breaker that supplies the power to the EVSE.



Warning:

Hazardous voltage

- Be careful when you work with electricity.
- The power supply comes on.
- A series of self-checks start, to make sure that the EVSE works correctly and safely.
- If the EVSE detects a problem, the error LED comes on.

8.3 Set up the EVSE

Preliminary requirements

	<ul style="list-style-type: none">• Mobile device with the <i>TerraConfig</i> app		<ul style="list-style-type: none">• Label with PIN. Refer to section 10.6.
---	---	---	--

Procedure

1. Open the *TerraConfig* app.
2. Enter the PIN.
3. Do these steps, on the *TerraConfig* app:
 - a. Update the product firmware. Do this step again until the *TerraConfig* app does not detect newer firmware.
 - b. Adjust the parameter settings for your EVSE configuration

9 Troubleshooting

9.1 Troubleshooting procedure

1. Try to find a solution for the problem with the aid of the information in this document.
2. If you cannot find a solution for the problem, contact your local representative of the manufacturer. Refer to section 1.12.

9.2 Troubleshooting table

Problem	Possible cause	Possible solution
The current is too high	There is an overload on the EV side	<ol style="list-style-type: none"> 1. Examine the EV charge cable connection. 2. Connect the EV charge cable correctly.
	The voltage from the grid is too high.	Make sure that the voltage from the grid is not more than specified.
There is a failure in the electrical connections	The installation of the electrical connections is not correct.	<ol style="list-style-type: none"> 1. Examine the electrical connections. 2. Make sure that the connection of the phase and line and neutral wires is correct. 3. If necessary, adjust the electrical connections. Refer to chapter 11.
The EVSE is overheated	The ambient temperature exceeds the operation temperature specification	The EVSE will decrease the current output.
	Internal charger malfunction	<ol style="list-style-type: none"> 1. Do a check of the operation temperature on the type plate. 2. Make sure that the voltage from the grid is not more than specified. 3. If you can not solve the problem, do not use the EVSE. Contact your local company representative or a qualified electrical contractor. Refer to section 1.12.

Problem	Possible cause	Possible solution
There seems to be residual current in the charging circuit	There is residual current in the charging circuit.	<ol style="list-style-type: none"> 1. De-energize the EVSE. Refer to section 10.3. 2. Contact your local representative of the manufacturer or a qualified electrical contractor. Refer to section 1.9.
	The monitoring sensor for residual current has a failure.	Replace the monitoring sensor for residual current.
There is a relay contact failure	The relay contact is overheated or defective.	<ol style="list-style-type: none"> 1. Examine the relay contact. 2. If necessary, adjust the current. 3. If necessary, replace the relay contact.
The error <i>Missing earth</i> shows	The EVSE is not earthed correctly.	<ol style="list-style-type: none"> 1. Do a check of the protective earth line of the connector of the AC input. 2. Install the protective earth conductor.
There is no internet connection	The internet connectivity between the EVSE and the router is lost.	Connect the EVSE to the internet.
	The RJ45 cable or plug is defective	If it is necessary, replace the RJ45 cable or plug.
	There is no WiFi	Do a check of the WiFi signal strength at the site.
	There is no 3G/4G connectivity	<ol style="list-style-type: none"> 1. Do a check of the Nano-SIM card connections. 2. Do a check of the 3G/4G signal strength at the site.
The EV is not charged	There is a problem with the EVSE	<ol style="list-style-type: none"> 1. Make sure that the power supply to the EVSE is on. 2. Examine the EVSE to find if it is working correctly. 3. Examine the <i>ChargerSync</i> app and the charge LED to make sure that the charging session is authorized. 4. Start the charging session.

Problem	Possible cause	Possible solution
	The EV charge cable is defective.	<ol style="list-style-type: none"> 1. Examine the EV charge cable. 2. If the standard supplied EV charge cable is defective, replace the EV charge cable. Refer to section 7.5.2.
The EV connection or authorization process fails	The EV charge cable is defective.	<ol style="list-style-type: none"> 1. Examine the EV charge cable. 2. If the standard supplied EV charge cable is defective, replace the EV charge cable. Refer to section 7.5.2.
	The EV charge cable is not connected correctly.	<ol style="list-style-type: none"> 1. Examine the connection of the EV charge cable. 2. If necessary, connect the EV charge cable.
	There is a problem with the <i>ChargerSync</i> app or the RFID card.	<ol style="list-style-type: none"> 1. Make sure that you have registered in the <i>ChargerSync</i> app. 2. Make sure that you use a RFID card that the manufacturer provided. 3. Make sure that the RFID card is added on the <i>ChargerSync</i> app. 4. Start the <i>ChargerSync</i> app. 5. Start the authorization process.

9.3 De-energize the EVSE

1. Open the breaker that supplies the power to the EVSE.
2. Wait for minimum 1 minute.

10 Technical data

10.1 EVSE Type

The EVSE type is a code.
The code has 10 parts: A1 - A10.

Code part	Description	Value	Meaning of the value
A1	Brand name	Terra AC	-
A2	Type	W	Wallbox
		C	Column
A3	Power output	4	3.7 kW
		7	7.4 kW
		9	9 kW
		11	11 kW
		19	19 kW
		22	22 kW
A4	Cable type or socket	P	Type 1 cable
		G	Type 2 cable
		T	Type 2 socket
		S	Type 2 socket with shutter
A5	Cable length	-	No cable
		5	5 m
		8	8 m
A6	Authorization	R	RFID enabled
		-	No RFID
A7	Ethernet	-	Single
		D	Double
A8	Metering	M	Certified for MID (only with display)
		-	Not certified for MID
A9	SIM slot	C	Yes
		-	No
A10	Display	D	Yes
		-	No

Example

Terra AC W7-P8-RD-MCD-0

- A1 = Brand name = Terra AC
- A2 = Type = Wallbox
- A3 = 7, Power output = 7.4 kW

- A4 = Cable type, cable = Type 1
- A5 = 8 m
- A6 = authorization = RFID enabled
- A7 = Ethernet = double
- A8 = metering = Certified for MID
- A9 = SIM slot = applicable
- A10 = display = yes
- The '0' is an empty field.

10.2 General specifications

Parameter	Specification
Safety standards	<ul style="list-style-type: none"> • UL 2594, UL 2231-1, UL 2231-2, UL 1998 • NMX-J-667-ANCE • CSA C22.2.NO.280
Certification	UL portfolio: <ul style="list-style-type: none"> • Single phase • Single phase with display
IP or NEMA rating	The type plate shows the specification. Refer to section 2.3.
IK rating according to IEC 62262 (enclosure and display)	IK10 IK8+ for an operation temperature between -35 and -30 °C
Codes and standards	FCC Part 15 Class B ENERGY STAR

10.3 Ambient conditions

Parameter	Value
Operation temperature	-30°C ⁴ to +55°C
Storage temperature	-40°C to +85°C
Storage conditions	Indoor, dry
Relative humidity	<95%, non-condensing

10.4 Mass

EVSE type	Weight [kg]
Terra AC wallbox, Type 1 (North America, Terra AC Wx-Px-xxxxx)	12.7 (80A)

10.5 Protective device compliance

10.5.1 Protective device compliance (North America, Terra AC Wx-Px-xxxxx)

Requirements	Specifications
Dedicated upstream protection device(s)	Breaker
EVSE internal Ground Fault Protection	20 mAAC
Upstream overcurrent protection breaker	Breaker rating: <ul style="list-style-type: none"> 100A for a 80 A rated EVSE



Note: The breaker value depends on the diameter and the length of the cable, the EVSE rating, and the environmental parameters (for the electrician to decide).

The breaker serves as the main disconnect switch to the EVSE.

⁴ Based on manufacturer test result

10.6 Parts included in the delivery

Parameter	Specification
EVSE	Refer to the type plate. Refer to section 2.3.
Mounting screws	M6 x80
Plugs for mounting screws (serviceable for a brick wall)	10x 100 mm
Installation template	-
Size for conduit	1" for AC input 3/4" for Smart Meter or Ethernet
RFID card	MIFARE
Label with PIN	To log in to the <i>TerraConfig</i> app.

10.7 Requirements for the wall

Parameter	Value
Wall thickness	Minimum 120 mm
Wall strength	The wall must be serviceable for the items listed below: <ol style="list-style-type: none"> 1. The weight of the EVSE. Refer to section 10.4. 2. The torque for the lower mounting screws. Refer to section 10.14.
Wall material	The mounting surface must be flat and stable, for example a finished, brick or concrete wall.

10.8 Noise level

Parameter	Specification
Noise level	Less than 40 dB(A)

10.9 Dimensions

10.9.1 AC input with EV charge cable

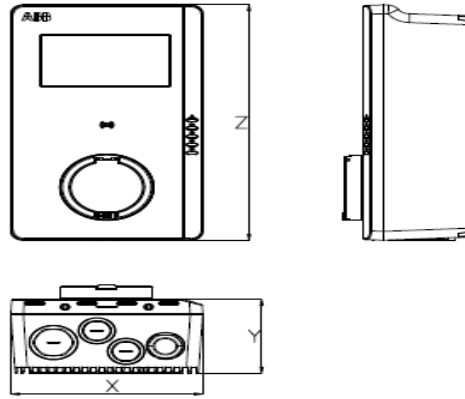

X Width of the EVSE
Y Depth of the EVSE

Z Height of the EVSE

Parameter	Value [mm]
X	230
Y	125
Z	400

10.9.2 Space requirements for installation

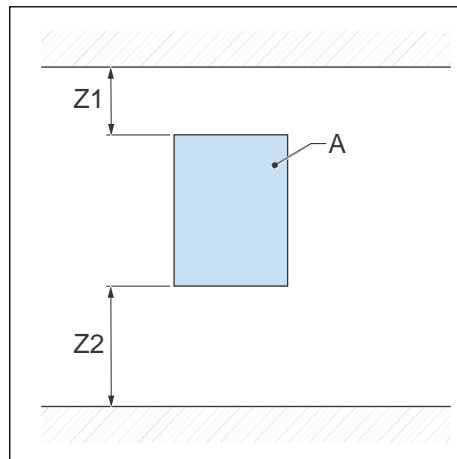

A EVSE

Parameter	Specification [mm]	Specification [inches]
Z1	> 200	> 8
Z2 (indoor use)	450 to 1200	18 to 48
Z2 (outdoor use)	600 to 1200	24 to 48

10.10 AC input specifications

10.10.1 General specifications

Parameter	Specification
Frequency	50 Hz or 60 Hz
Overvoltage category	Category III
Protection	Overcurrent
	Overvoltage
	Undervoltage
	Earth fault, including DC leakage protection ⁵
	Integrated surge protection

10.10.2 AC input specifications

Parameter	Specification
Input AC power connection	240 VAC
Earth (ground) fault protection	internal 20 mA AC CCID

10.11 General logic interface specifications

Parameter	Specification
Connectivity	Mobile communication with Nano-SIM socket type M2M (Machine To Machine) <ul style="list-style-type: none"> • 2G (GSM) • 3G (WCDMA) • 4G (LTE)
Smart meter communication	Modbus RTU (RS485) Modbus TCP/IP
Ethernet	1x 10/100 BaseT, RJ45 Socket
Extra ethernet (daisy chain)	1x 10/100 BaseT, RJ45 Socket
WiFi (WAN)	IEEE 802.11 b/g/n, 2.4 GHz
Bluetooth	BLE 5.0
RFID	MIFARE ISO/IEC 14443A RFID cards
Compatible mobile device operating systems	<ul style="list-style-type: none"> • Android 4.4 or higher • iOS 8 or higher

10.12 Cable specifications

10.12.1 AC input cable

Parameter	Specification
EV charger station connection type	Terminal /lugs and screws
Wire size for the terminal (PE)	8 AWG
Wire size for the terminal (L1,L2)	2 AWG
Strip length	14 mm (L1,L2)/8.5mm (PE)
Cable shielding (optional)	The local rules require shielded cables. The cable shielding must be connected to the PE rail at the two ends of the cable.
Diameter of the phase conductors	Refer to the local rules.
Diameter of the PE conductor	The same as the diameter of the phase conductors

- Consult your local electrical codes for the correct wire size, based on the environment, the conductor type and the rating of the EVSE.
- The wire AWG is based on the copper wire type.

10.12.2 Ethernet cable specifications

Parameter	Specification
EVSE connector type	RJ45 Modular jack
Cable type	Category 5 (Cat 5)

10.12.3 RS485 cable specifications

The RS485 cable specifications apply to smart meter ModBus RTU communication.

Parameter	Specification
Connector type for the EV charging station	Terminal block plug and screws
Conductor type	Twisted pair, shielded cable (recommended)
Conductor size for the terminal block plug (allowed)	Europe (IEC) cross-sectional area: 2.5 mm ² to 0.5 mm ² North America (UL): 12 AWG to 30 AWG
Conductor size for the terminal block plug (recommended)	Minimum 24 AWG (0.5 mm ²)
Strip length	5 mm
Terminal connections	485A: RS485 Positive/A/D0 485B: RS485 Negative/B/D1 Common isolated ground for shielded cable
ModBus RTU baud rate	9600 bps
ModBus RTU bus primary/secondary	EVSE is Modulus primary/secondary configurable via <i>TerraConfig</i> app

- Consult your local electrical codes and the wiring requirements of your smart meter device for the correct wire size.
- The wire AWG and cross-sectional area are based on the copper wire type.

10.12.4 Dry contacts input

The dry contacts input is the single contact provided by the user.

Parameter	Specifications
EVSE connector type	Terminal block plug and screws
Wire size for the terminal block plug (allowed maximum)	<ul style="list-style-type: none"> • 2.5 - 0.5 mm² (Europe) • 12 - 30 AWG (North America)
Wire size for the terminal block plug (recommended)	24 AWG (0.5 mm ²) minimum

Required torque	0.5 Nm
-----------------	--------

Parameter	Specifications
Strip length	5 mm
Terminal connections	<ul style="list-style-type: none"> PE/Shield: Contact input terminal 1 or 2 Configuration input: Contact input terminal 2 or 1

Wire AWG and cross section: based on a copper wire type

10.12.5 Dry contacts output

The dry contacts input is the single contact in the EVSE.

Parameter	Specifications
EVSE connector type	Terminal block plug and screws
Wire size for the terminal block plug (allowed maximum)	<ul style="list-style-type: none"> 2.5 - 0.5 mm² (Europe) 12 - 30 AWG (North America)
Wire size for the terminal block plug (recommended)	20 AWG (0.75 mm ²) minimum
Required torque	0.5 Nm
Strip length	5 mm
Terminal connections	<ul style="list-style-type: none"> Configuration output dry contact 1: Contact output terminal 1 Configuration output dry contact 2: Contact output terminal 2
Contact rated load	125 VAC/30VDC at 3A

The wire AWG and cross section are based on a copper wire type.

10.12.6 EV charge cables specifications

Parameter	Value [m]
Length	8

10.13 AC outputs specifications

10.13.1 AC output specifications

Parameter	Specification
AC output voltage range	240 V AC (1 phase)
Connection standard	Type 1 cable according to SAE J1772

Parameter	Specification [Nm]
Terminal block for the AC input	2.5
Terminal block for the communication wires and the smart meter connections	0.5
Terminal block for the EV charge cable	2.5
Mounting screws	4.4