



Instruction Manual

Model: 93404-182428

IMPORTANT SAFEGUARDS

When using electrical appliances, basic safety precautions should always be followed including the following:

1. Read all instructions.
2. To protect against risk of electrical shock do not put the **plug, power cord, bowl and base unit** in water or other liquid.
3. Unplug from outlet when not in use, before putting on or taking off parts and before cleaning. Flashing light (or identify other means used) indicates ready to operate. Avoid inadvertent contact with the touch screen.
4. Unplug from outlet when not in use and before cleaning. Allow to cool before putting on or taking off parts.
5. Always attach plug to appliance first, then plug cord into the wall outlet. To disconnect, turn any control to "off", then remove plug from wall outlet.
6. Keep body parts, jewelry and loose clothing away from moving parts and fitted tools/attachments. Avoid contacting moving flashing light indicates ready to operate. Avoid any contact with blades or moveable parts. Keep fingers out of discharge opening.
7. Always remove the blade before pouring contents from the bowl.
8. To reduce the risk of injury, never place cutter-assembly blades on base without jar properly attached.
9. Always operate blender with cover in place.
10. Keep hands and utensils out of container while blending to reduce the risk of severe injury to persons or damage to the blender. A scraper may be used but must be used only when the blender is not running.
11. Never use a damaged appliance. Get it checked or repaired.
12. Do not exceed the maximum fill level marked on the inside of the bowl.

13. Never let the power unit, cord or plug get wet.
14. Be careful when handling or touching any part of the appliance when being used in the cook mode or after cooking. In particular the bowl, lid and tools as they will remain HOT long after the appliance has been switched off.
15. Keep hands and utensils away from moving blades or discs while processing food to reduce the risk of severe injury to persons or damage to the food processor. A scraper may be used but must be used only when the food processor is not running.
16. To reduce the risk of injury, never place cutting blade or discs on base without first putting bowl properly in place.
17. Be certain cover is securely locked in place before operating appliance.
18. Never feed food by hand. Always use food pusher.
19. Do not attempt to defeat the cover interlock mechanism.
20. Do not fill the bowl above the marked maximum fill line (or rated capacity) to avoid risk of injury due to damage to the cover or bowl.
21. Do not touch hot surfaces. Use handles or knobs.
22. Use the handles to remove and carry the bowl. Use oven gloves when handling the hot bowl and hot tools.
23. The underside of the bowl will remain hot long after the heating has stopped. Use caution when handling and use a work surface protection mat when placing the bowl on heat sensitive surfaces.
24. Be careful of steam escaping from the bowl particularly when removing the lid or filler cap.
25. Do not remove the lid or filler cap whilst liquid is boiling. Scalding may occur if the lid is removed during the brewing cycles.
26. Always close the filler cap when using the chopping function.
27. Only use the bowl and tools supplied with this appliance. Never use the bowl with any other heat source.
28. Never operate the appliance in the cook mode with the bowl empty.
29. Do not use the blender lid to operate the processor. This appliance will be damaged and may cause injury if the interlock mechanism is subjected to excessive force.
30. When using this appliance ensure it is positioned on a level surface away from the edge. Do not position below overhanging cupboards.
31. For the correct and safe operation ensure that the bowl base and temperature sensors are clean and dry before cooking.
32. **CAUTION: In order to avoid a hazard due to inadvertent resetting of the thermal cut-out, this appliance must not be supplied through an external switching device, such as a timer, or connected to a circuit that is regularly switched on and off by the utility.**

33. Always ensure food is thoroughly cooked and is piping hot before eating.
34. Food should be eaten shortly after cooking or allowed to cool quickly and then refrigerated as soon as possible.
35. Misuse of your appliance can result in injury.
36. A short power-supply cord is used to reduce the risk resulting from it being grabbed by children, becoming entangled in, or tripping over a longer cord.
37. This appliance is not intended for use by persons (including children) with reduced physical, sensory, or mental capabilities, or lack of experience and knowledge, unless they are closely supervised and instructed concerning use of the appliance by a person responsible for their safety. Close supervision is necessary when any appliance is used by or near children. Children should be supervised to ensure that they do not play with the appliance.
38. Children shall not play with the appliance.
39. This appliance shall not be used by children. Keep the appliance and its cord out of reach of children. Never let the cord hang down where a child could grab it.
40. **Warning: Be careful when handling the sharp cutting blades, emptying the bowl and during cleaning. Blades are sharp. Handle carefully.**
41. Blade assembly is sharp, not locked in place and removable. Handle with care. When handling blade assembly, always hold by the shaft.
42. To avoid a risk of injury, before pouring with the cover removed, carefully remove the blade assembly.
43. Always disconnect the appliance from the supply if it is left unattended and before assembly, disassembly or cleaning.
44. Do not operate any appliance with a damaged cord or plug or after the appliance malfunctions, or is dropped or damaged in any manner. Contact the manufacturer at their customer service email (andy.huang@cofarcn.com) for information on examination, repair, or adjustment.
45. Only use the appliance for its intended domestic use. We will not accept any liability if the appliance is subject to improper use, or failure to comply with these instructions.
46. The maximum load for blending function was 800 g carrots / 1200 g water.
47. Be careful if hot liquid is poured into the food processor or blender as it can be ejected out of the appliance due to a sudden steaming.
48. The appliance is only to be used with the stand provided.
49. The appliance is for household and indoor use only.
50. Avoid spillage on the connector.
51. Do not disassemble the base of cup (including handle enclosure), it's not for user maintenance.
52. After the motor stop working (if it was) , the cooling fan will still keep working for another 2mins



53. **Surfaces are liable to get hot during use.**

54. For how to clean the surfaces in contact with food please refer the paragraph of Care and Cleaning.

55. **CAUTION: Ensure that the appliance is switched off before removing it from the stand.**

56. **Before plugging in, Make sure your electricity supply is the same as the one shown on the underside of your appliance.**

57. **WARNING: THIS APPLIANCE MUST BE GROUNDED.**

58. The use of attachments, including canning jars, not recommended by the manufacturer may cause a risk of injury to persons.

59. Do not use outdoors.

60. Do not let cord hang over edge of table or counter. Do not let cord contact hot surface, including the stove.

61. Do not place on or near a hot gas or electric burner, or in a heated oven.

62. When blending hot liquids or operating in the heating mode, open or remove each non-pouring lid or cap, and close any edge cover openings intended for pouring.

63. Allow to cool before assembling or disassembling parts and before cleaning the appliance.

64. Intended for countertop use only.

65. **WARNING: Spilled food can cause serious burns. Keep appliance and cord away from children. Never drape cord over edge of counter, never use outlet below counter, and never use with an extension cord.**

66. Extreme caution must be used when moving an appliance containing hot oil or other hot liquids.

67. Vented lid is to remain in place over the cover opening when blending hot liquids or operating in the heating mode.

68. Do not use appliance for other than intended use.

SAVE THESE INSTRUCTIONS

HOUSEHOLD USE ONLY

1, Product overview

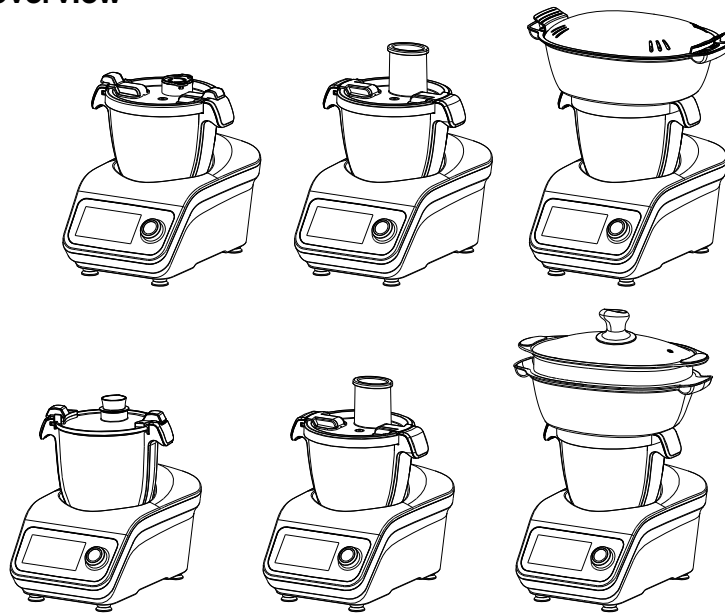

2, Parts

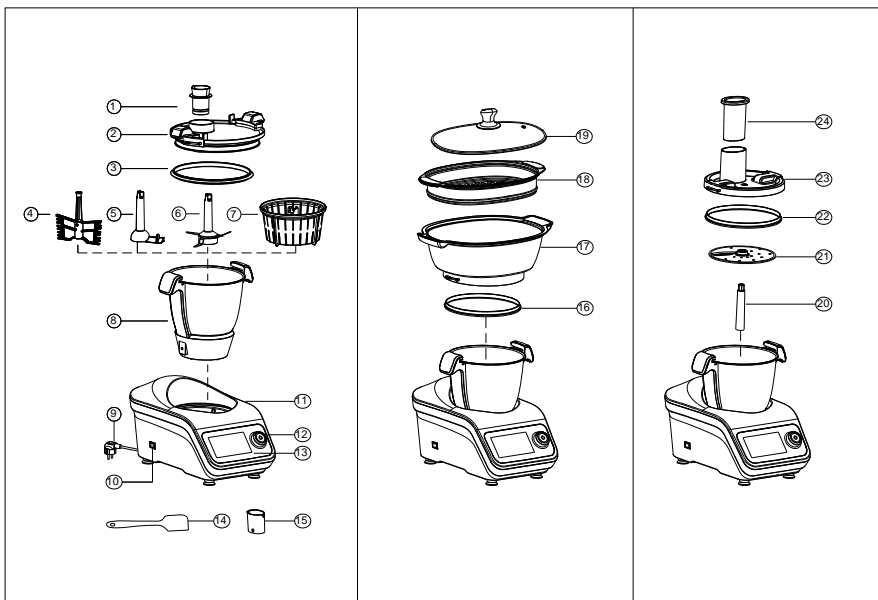
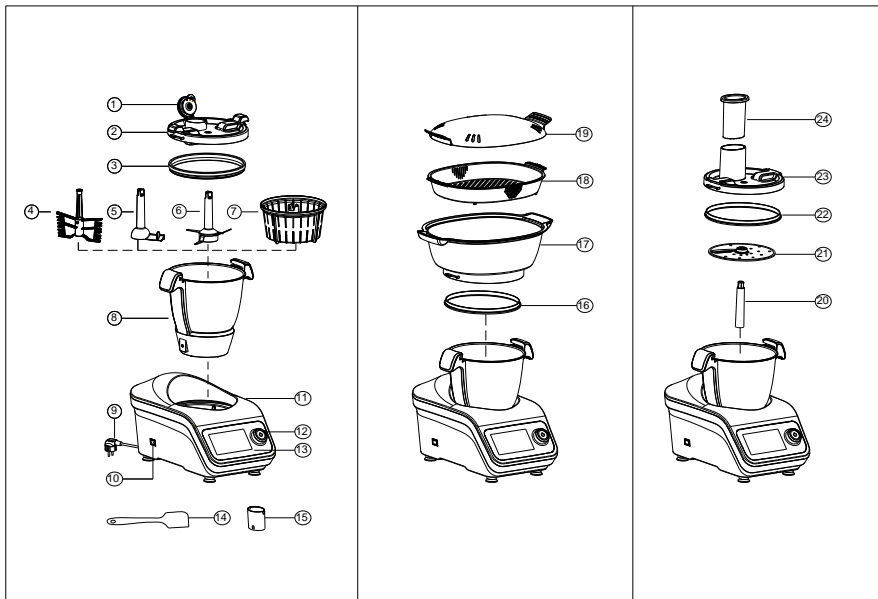

3, Display screen

1) DIYUI

30/31/32

2)

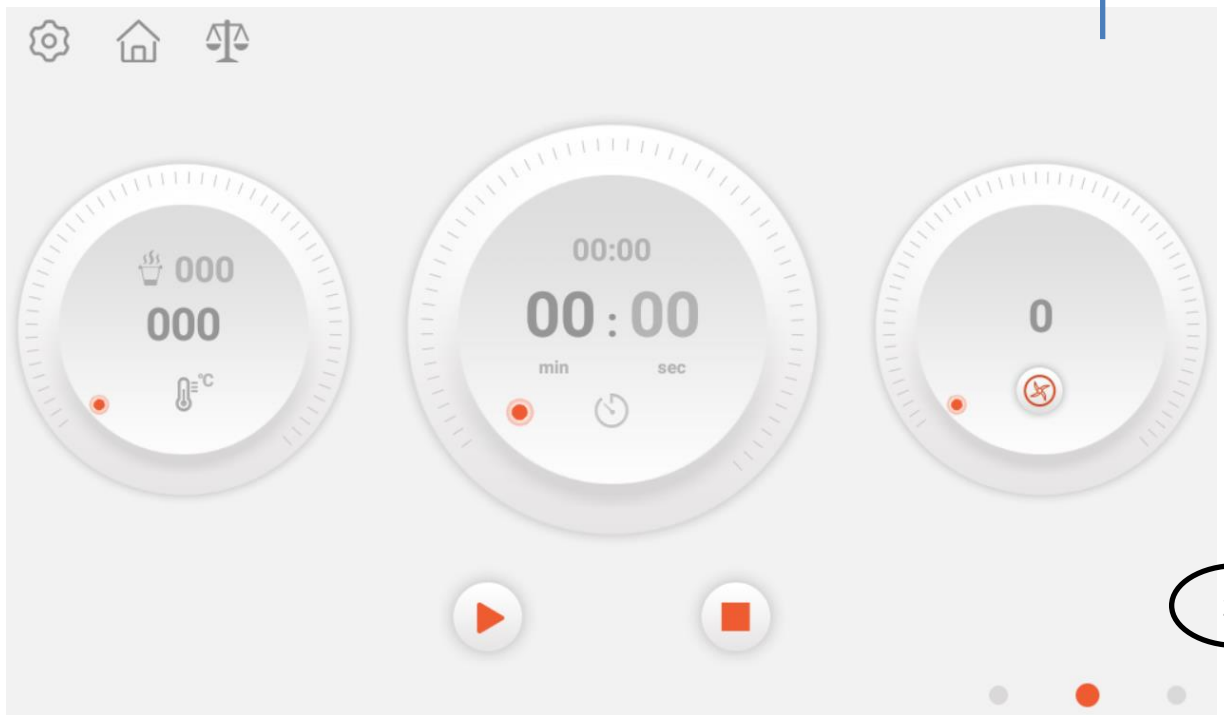

Auto programs UI

33

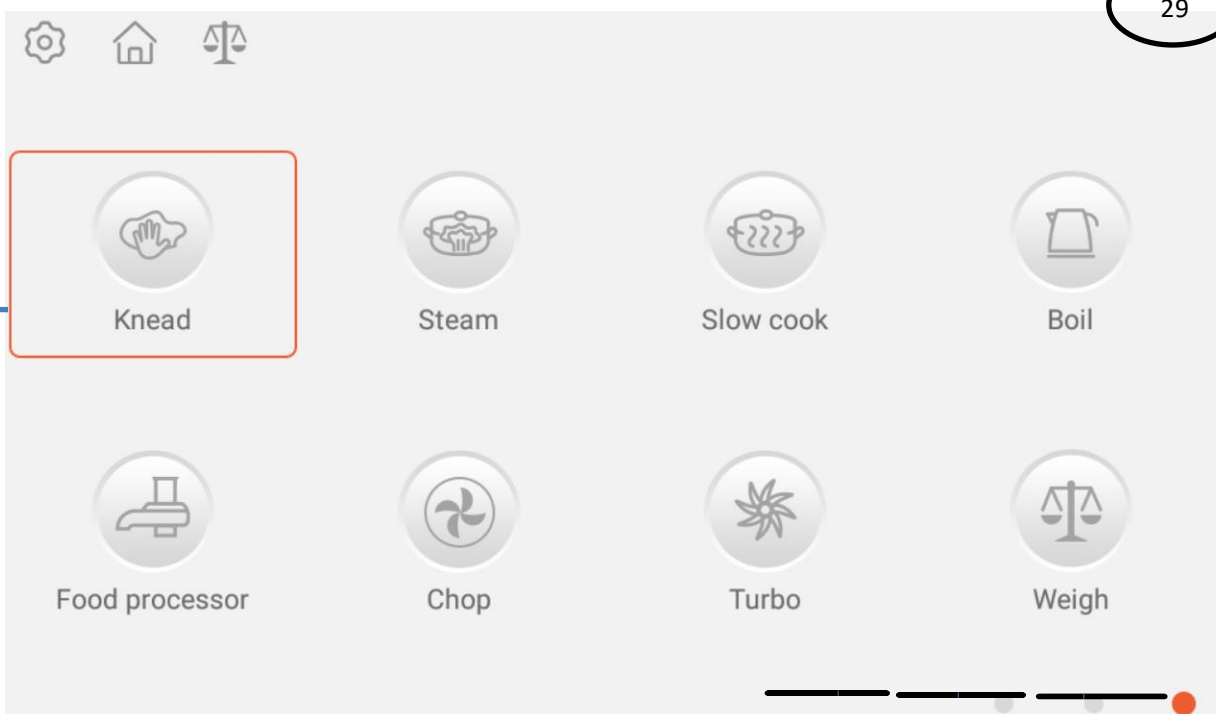

3) Recipe UI

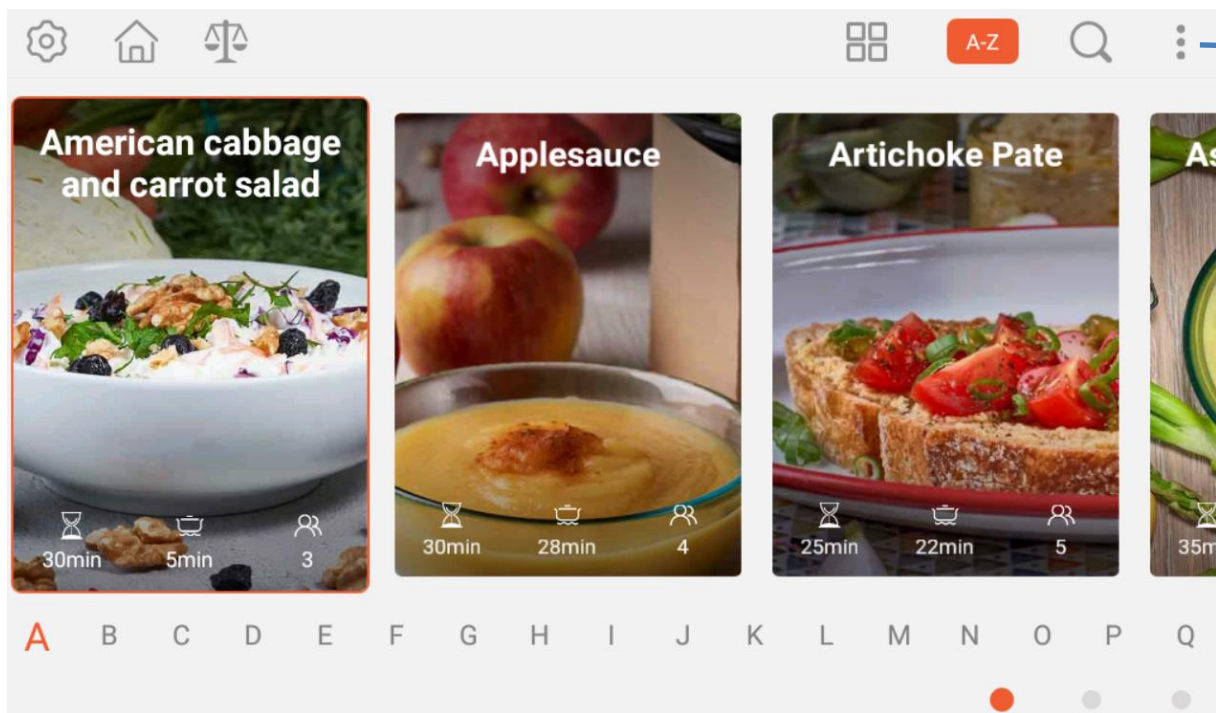

37

38

4) Setup UI

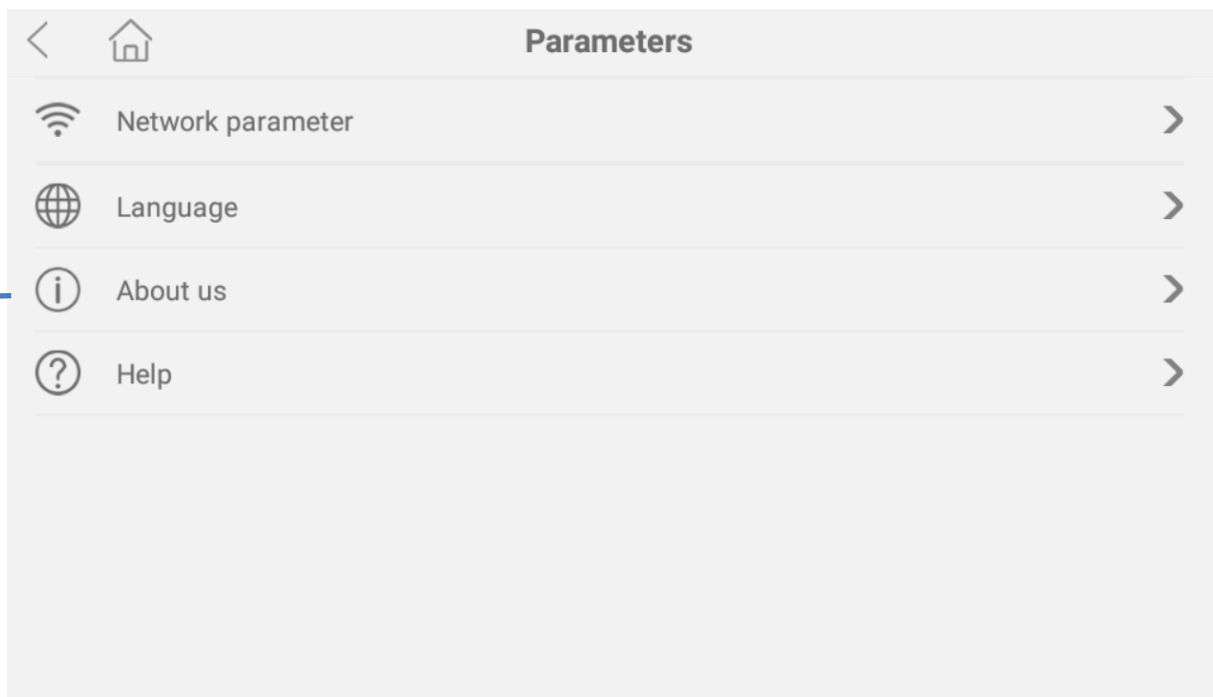

39

5) HomeUI

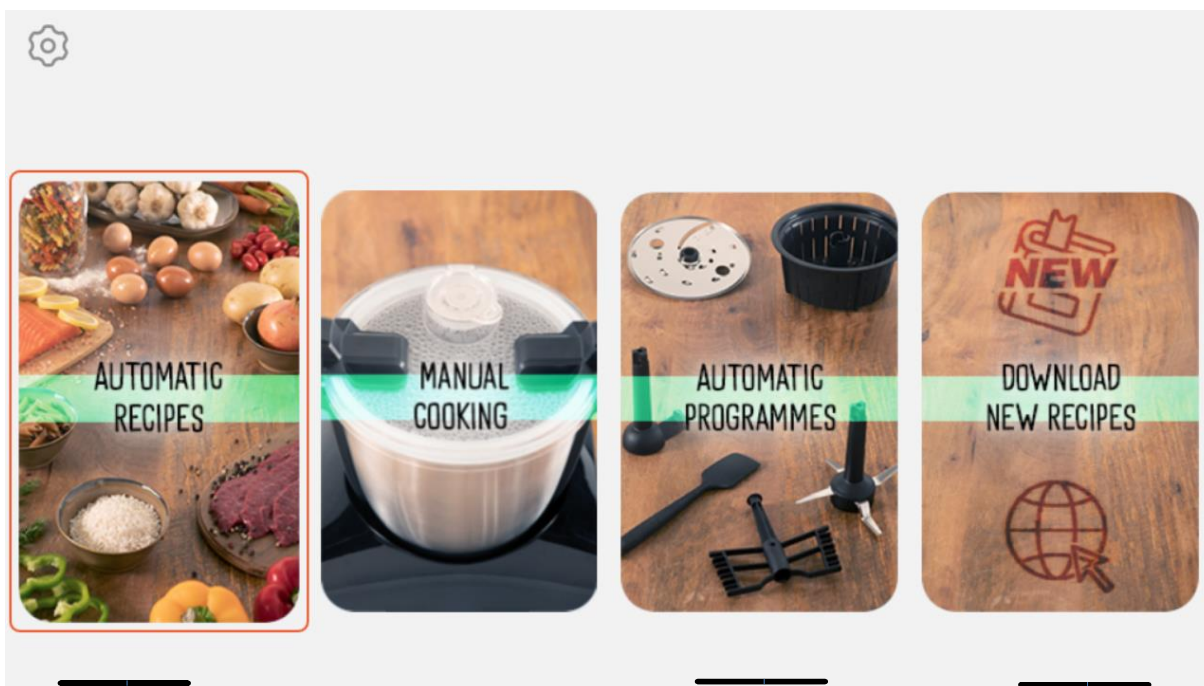

41

4, Key Parts

No.	Name	No.	Name	No.	Name
1	Filler cap	16	Seal of deep steamer basket	31	Home Button
2	Blender Lid	17	Steamer basket, deep	32	Weight Button
3	Blender lid seal	18	Steamer basket, shallow	33	Function Button
4	Whisk	19	Lid for steamer basket	34	Sort management
5	Stir paddle	20	Driving shaft	35	A-Z
6	Blade	21/21A	Slicer/shred	36	Search Button
7	Steam basket	22	Seal for FP lid	37	More Button
8	Blender jug	23	FP lid	38	A-Z button
9	Power cord	24	Pusher	39	Setup UI
10	Main switch	25	Temperature Button	40	Recipes UI
11	Base unit	26	Timer Button	41	DIY UI
12	Knob	27	Speed Button	42	Auto program UI
13	Display screen	28	Star/Pause/Stop Button	43	Download UI
14	Spatula	29	Interface shift dot		
15	Measuring cup	30	Setup Button		

5, To set-up before use

1

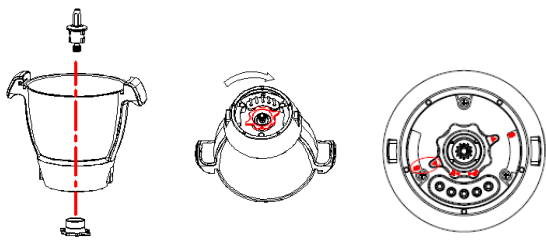

Place the drive shaft correctly locked into the jug .

2

Insert the Jug into the Main Unit .Press down firmly to lock into place .(LOGO in front),Max in back)

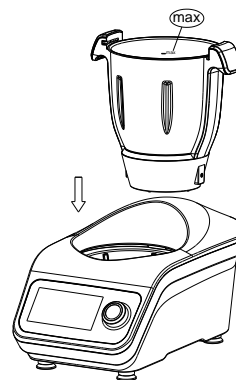

3

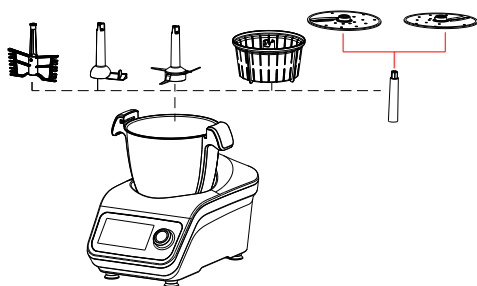

Choose difference accessories for difference cooking purpose .

4

Add the ingredients or water to the jug .If need food processor function . Then you need to attach food processor lid and put ingredients directly through food dispenser .

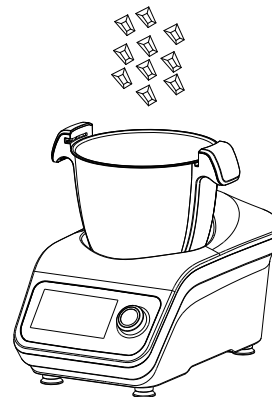

5

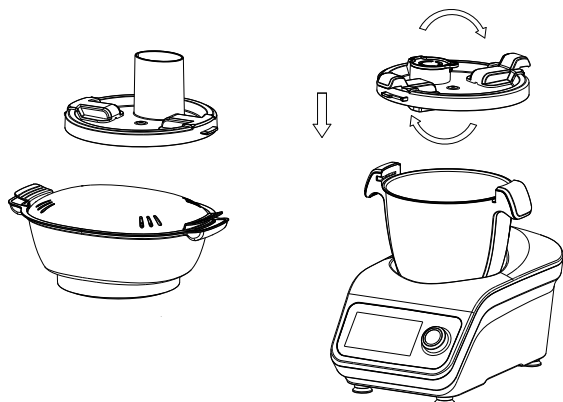

Attach the Blend lid, or FP lid or Steamer

6

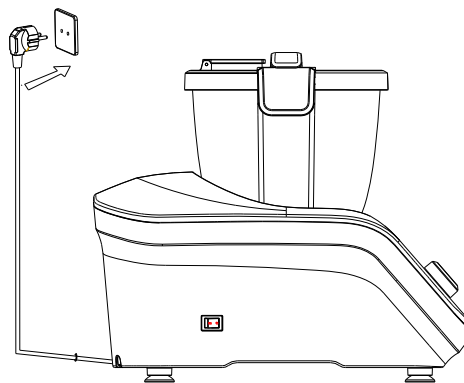

Plug your Powercord into the main base then, Switch on. When main base has the Power cord ,not assemble the Power cord

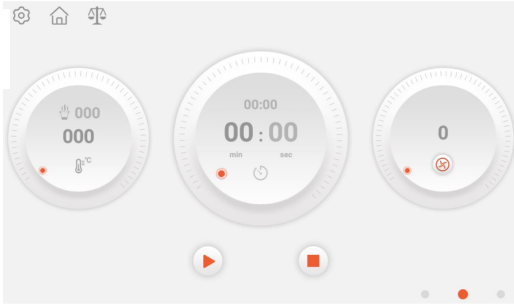

7



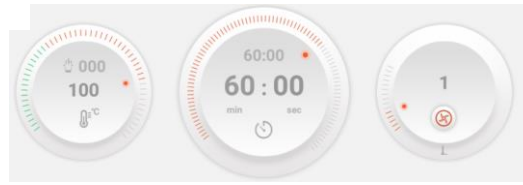

Slide the corresponding icon or rotate the knob to set the temperature, time and speeds. Click the minute or second in the time icon to quickly set the exact time. Reverse function: Click the icon  for shift rotating direction

8



Click  after set the temperature, time and speed to start, then the icon will change to , the machine is working now.

Click  or push button in knob to pause working, click  or continuously press the push button in knob to stop working and exit the program.

9



By sliding left direction in screen or click the right dot in red circle or turn the knob in clockwise to go to common function menu. Click the  or click the middle dot in red circle to go back to the initial step for reset.

10

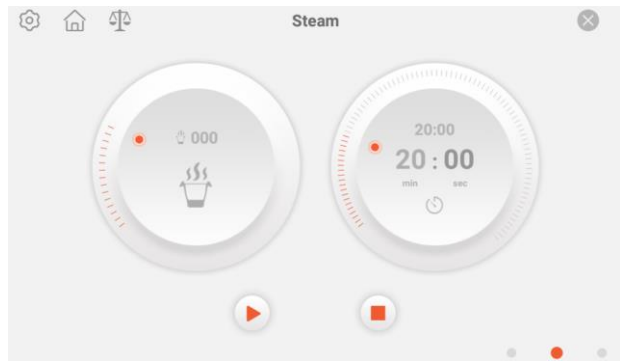

Click the function icon in common function menu to go to the corresponding screen interface. Start working after completing the step 7 and 8. Click  to exit this interface. This icon is for steaming.



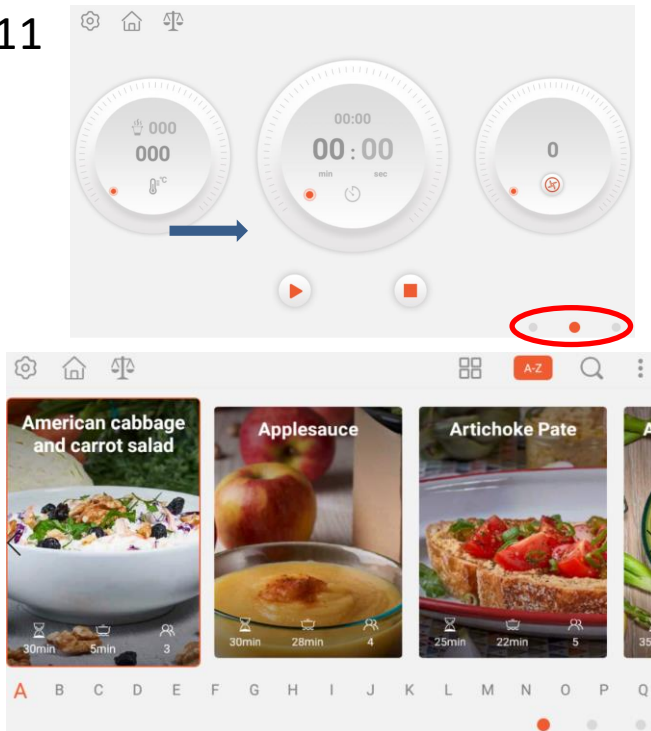



11



By sliding right in screen or click the left dot in red circle or turn the knob in anticlockwise to go to recipe menu. Click the  or click the middle dot in red circle to go back to the initial step for



12

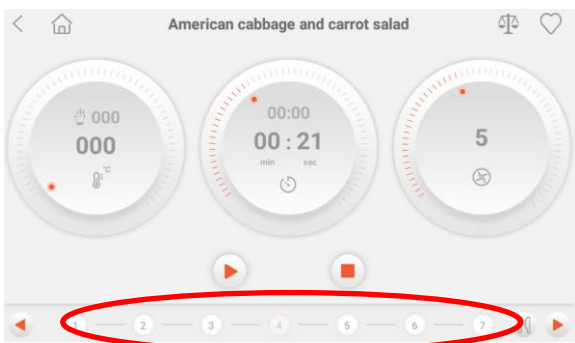

Click the recipe photo, enter into recipe interface, click     to check all the recipe details. Click  to start and  for favorite collection.

13



The recipe has preset parameter. Click  to start. The number in red circle stand for each working step, click  to check all the recipe details.

14

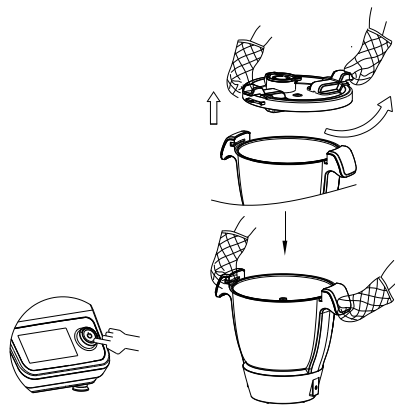

After cooking ,Screen will shows end .Press the rotary knob and it will stop cooking .If you want to suspend during cooking .Press the rotary knob . Then press again and the cooker will continue cooking . The cooker will stop cooking if you long press the rotary knob.

15

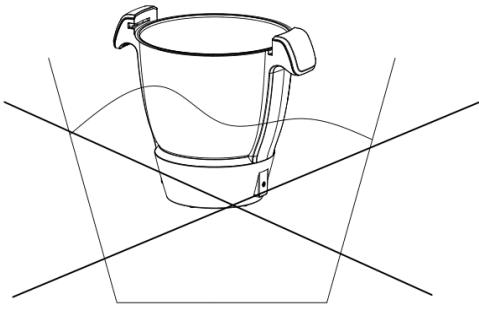

Blender jug can be washed by dry dishcloth or wash it with water, But do not immersed in water ; Do not put it into the dish-washing machine

16

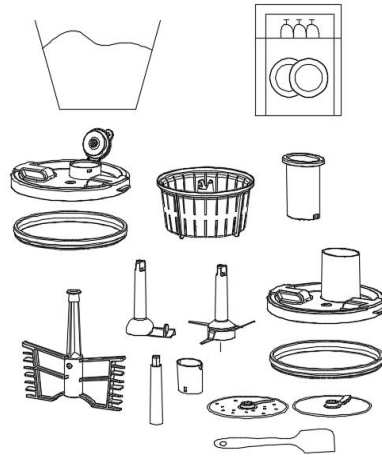

Accessories which can be put into dishwasher.



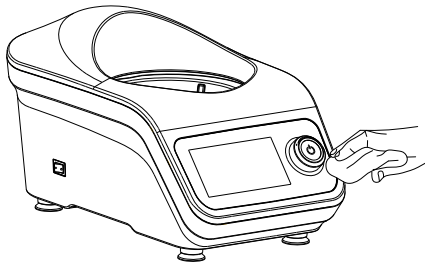







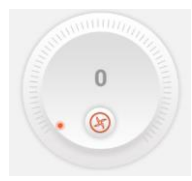

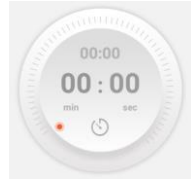



17





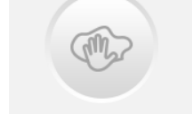

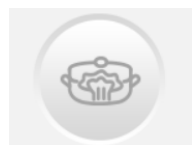



















Clean the main unit

6, Control Panel Overview

Serial number	Icon	Function description
12		<p>(1) Can be used to setting temperature ,time, speed ;or UI, Auto program, recipe.</p> <p>(2) Press the knob and the cooker will suspend when cooking .It will continue cooking if your press again. Or confirm your choice.</p> <p>(3) Long push the knob and the cooker will stop cooking .</p> <p>(4) Press the knob after finish all setting and the cooking will start cooking .</p> <p>(5) It will automatically cancel if you long push the knob during setting .</p> <p>(6) When finish cooking ,Press the knob and the cooker will into standby mode .</p>

27.1		Reverse The speed rang:1-3	
27.2		Speed: Click  to shift between clockwise and reverse Speed range: 0-12	
26		Display set time parameter:0-90 minute Operation time display: 0-90 minute	
25.1		Display set temp parameter Temp rang: 37-120°C After 37, 40°C, in intervals of 5°	
25.2		Close/Open Icon	
25.3		Food /ingredients temp,After 37, 40°C, in intervals of 5°	
28		 : star,  : pause  : stop Botton	
30		Setup Button: set or check robot cook info including:Wifi,System version,Language ,etc.	
31		Home Butto: Home page	
32		Weight button	
33.1		Knead: Time: 3 (Range:2-4) minutes Temp: 000(Range:000-37)°C Speed: 1(Range:1-2)	
33.2		Steam: Time: 20 (Range:1-60) minutes Steam flow: Fast/Medium/Slow Time count down starts form 95°C	

33.3		<p>Slow Cook</p> <p>Time: 60(Range:10-90) minutes</p> <p>Temp: 100(Range:60-100)°C</p> <p>Speed: 1(Range:1-3)</p>	
33.4		<p>Boil</p> <p>Temp: 100(Range:60-100)°C</p>	
33.5		<p>Food Processor</p> <p>Time: 30(Range:10-60) seconds</p> <p>Speed: 5(Range:4-6)</p>	
33.6		<p>Chop</p> <p>Time: 10s(Range:10s-4m)</p> <p>Speed: 6(Range:1-12)</p>	
33.7		<p>Turbo</p> <p>Time: 60s</p> <p>Speed: 12</p> <p>Press  or Press Knob and release to stop</p>	
33.8		<p>Weigh</p> <p>Max: 5Kgs</p> <p>5g interval</p>	
33.8.1		Tare	
33.8.2		End weighing	
34		Sort management	

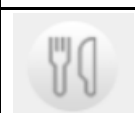
35		A-Z
36		search
37		More Including favorite collection and history
44		Exit
45		Favorite/History
46		Ingredients Picto
47		Cooking step
48		Chef's tips
49		Accessories Picto
50		Check recipe info including

7. Setting the time



7.1: Time range: 0-90minutes

7.2 click , click min or sec, slide or rotate the knob to set time

8. Setting the temperature



8.1: Temperature range: 37-130°C , with 5°C interval

8.2: Click  slide the picto or rotate the knob to set the temp

9. Setting the speed



9.1: Speed range: 0-12

9.2: click , slide the picto or rotate the knob to set the speed

9.3  :

click , shift to , with speed setting 1-3

9.4:  Speed 1-3:

 Speed 1-4:

 Speed 1-12

10. start,pause and stop

10.1  start

10.2  Pause

10.3  Stop

During standby mode,white and red lights flash. Red light underneath Knob is on when temperature is beyond 60°C,and white light is on when temperature is below 60°C, at any working mode

11, Suggested Usage

Method				
Function	Accessory	Speed	Time	Maximum cooking ingredients in one time
Meat Chopping	Chopping blade	Speed 8-12	60s	400g Beef / pork without bone/tendon
Ice Crush	Chopping Blade	Speed 8-12	10-20s	400g ice cube
Blender	Chopping Blade	Speed 12	1min	Maximum Capacity: 2000ml 800g carrot 1200g water
Chopping (Onion, Shallot, Celery, etc)	Chopping Blade	Speed 5	15s-30s	500g
Kneading	Chopping Blade	Speed 1	2mins	500g flour + 250g water + 20g oil
Slices ,Shreds (Carrot, Cucumber, Potato)	Slices discs	Speed 5-6	30s	500g
Soup	Stir paddle	Speed 1	Choose Soup function. Or you can setting the proper time , speed, temperature by your own .	Maximum Capacity 2000ml

12, Care and Cleaning :

12.1, Always switch off and unplug before cleaning.

12.2, Remove the lid and tool from the bowl before cleaning,

12.3, Power unit. Wipe with a damp cloth, then dry. Never use abrasives or immerse in water.

12.4, When there is burn mark on blender jug bottom, put some citric acid or lemons into water, heat 5~7 minutes, then remove the burn mark with a mop



12.5, Bowl/stirring paddle/blade. Wash the parts, then dry thoroughly. If food sticks or burns on the inside of the bowl, remove as much as possible using a spatula. Fill the bowl with warm soapy water and allow to soak. Remove any stubborn deposits using a cleaning brush. Any discolouration of the bowl will not affect its performance.

12.6 How to take out steam basket

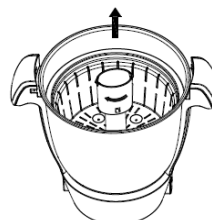
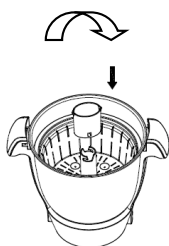
Put measuring cup into steam basket slot and rotate to fix. Then, take out.

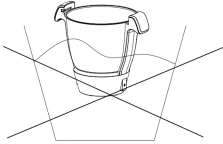
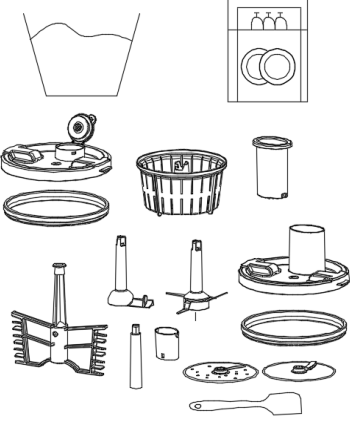

13. Cleaning and Maintenance

<p>Please unplug the power cord before cleaning ;</p> <p>Please use dry and soft cloth to clean power cord .</p> <p>Please use dry dishcloth to clean the main unit .Do not wash them with water or put it into the dish-washing machine .</p>	<p>Blender jug can be washed by dry dishcloth or wash it with water, But do not immersed in water ;Do not put it into the dish-washing machine</p> 
<p>Lid , Measuring cup , Blade , Mixing paddle , Steam basket, Steamer . etc .all above photo accessories can be washed by dish-washing machine .</p> 	<p>Metal brush , nylon brush , household cleaner, diluent , cleaning products will damage the surface of product structure ;</p> 

14. Product Specification

Model	93404-182428
Rated Voltage	120V, 60Hz
Rated Power	1300W
Heating Power	1000W
Mixing Power	600W
Bowl Capacity	2.0L
WIFI Frequency	2412~2462 MHz
WIFI Max transmitted power (with antenna gain)	18dBm
Modulation mode	OFDM, CCK
Antenna gain	2.5dbi

Note: If you are Having a problem with your appliances with cannot be solved by above mentioned, Please call our helpline or Visit our website

15 .Reset temperature control

When over temperature the Jug does not work , you can Press the temperature button to reset temperature control, after cooling the Jug ,the Jug can work.

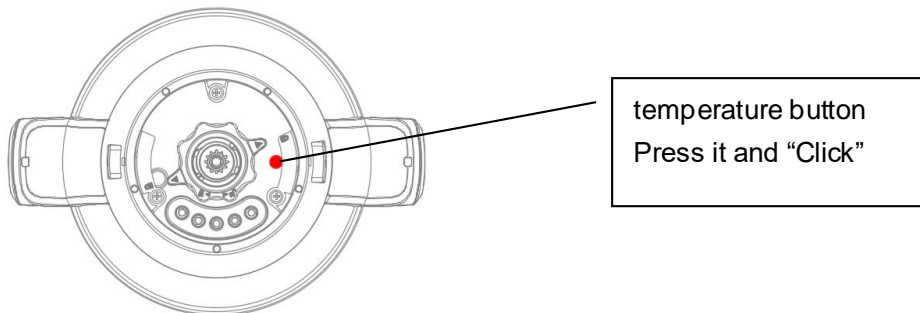

16. Accessories Overview

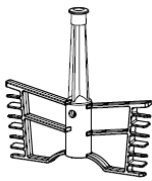
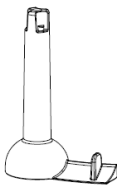
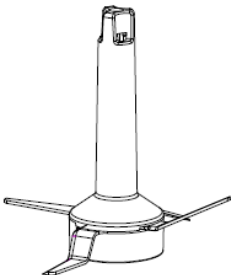
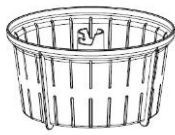
Key Part	Function	Speed	Time	Temperature°C	
	Whisk	Whip Egg white	4	2-4minutes	---
		Whip Cream	3	3-5 minutes	---
	Stirring paddle	Soup	1-2	1-90 minutes	100°C
		Other ingredients that need to heat	1-2	As perneed	As per need
	Blade	Meat Chopping	8-12	30-60s	---
		Ice Crush Sugar	8-12	10-20s	---
		Blender	8-12	1-2 minutes	---
		Chopping (Onion, Shallot, Celery etc)	5-7	15-60s	---
		Bean, Soybean, nut, peanut, Coffee bean, almond	12	2-3minute	---
		Kneading	1	1-2 minutes	---
	Steam basket	Rice etc.	---	20-30 minutes	Steam program: Small/Middle

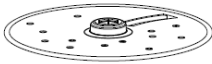
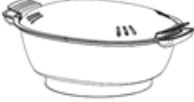
	Slicer/ shred disc	Slices	5-6	30-60s	Only Food processor program
	Steamer	Fish...	---	10-60 minutes	Steam program: Middle/Big

17. Firmware Update

- 1, Pls contact with qualified maintenance personnel for service.
- 2, Put machine bottom upwards, unscrew the cover of USB.

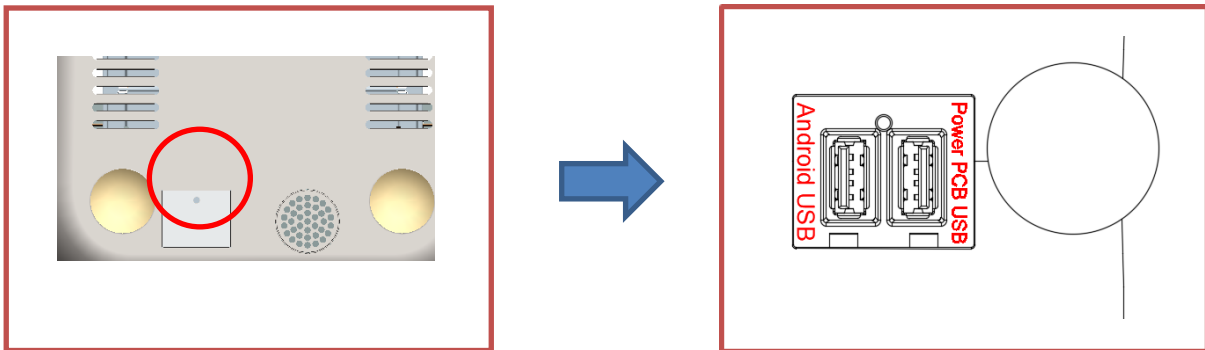

- 3, Put the dedicated USB into socket of Power USB or Android USB and connect dedicated update firmware.
- 4, Screw cover after update firmware is completed.

This device complies with Part 15 of the FCC Rules. Operation is subject to the following two conditions: (1) this device may not cause harmful interference, and (2) this device must accept any interference received, including interference that may cause undesired operation.

Changes or modifications to this unit not expressly approved by the party responsible for compliance could void the user's authority to operate the equipment.

NOTE: This equipment has been tested and found to comply with the limits for a Class B digital device, pursuant to Part 15 of the FCC Rules. These limits are designed to provide reasonable protection against harmful interference in a residential installation. This equipment generates uses and can radiate radio frequency energy and, if not installed and used in accordance with the instructions, may cause harmful interference to radio communications.

However, there is no guarantee that interference will not occur in a particular installation. If this equipment does cause harmful interference to radio or television reception, which can be determined

by turning the equipment off and on, the user is encouraged to try to correct the interference by one or more of the following measures:

Reorient or relocate the receiving antenna.

Increase the separation between the equipment and receiver.

Connect the equipment into an outlet on a circuit different from that to which the receiver is connected.

Consult the dealer or an experienced radio/TV technician for help.

This equipment complies with FCC radiation exposure limits set forth for an uncontrolled environment. This equipment should be installed and operated with a minimum distance of 20cm between the radiator & your body. This transmitter must not be co-located or operating in conjunction with any other antenna or transmitter.