

Antenna Specification

ITEM	SPEC.
Model Name	BM834
Frequency Range	2400MHz-2500MHz 5180MHz-5240MHz 5745MHz-5825MHz
MAX GAIN	3.0dBi

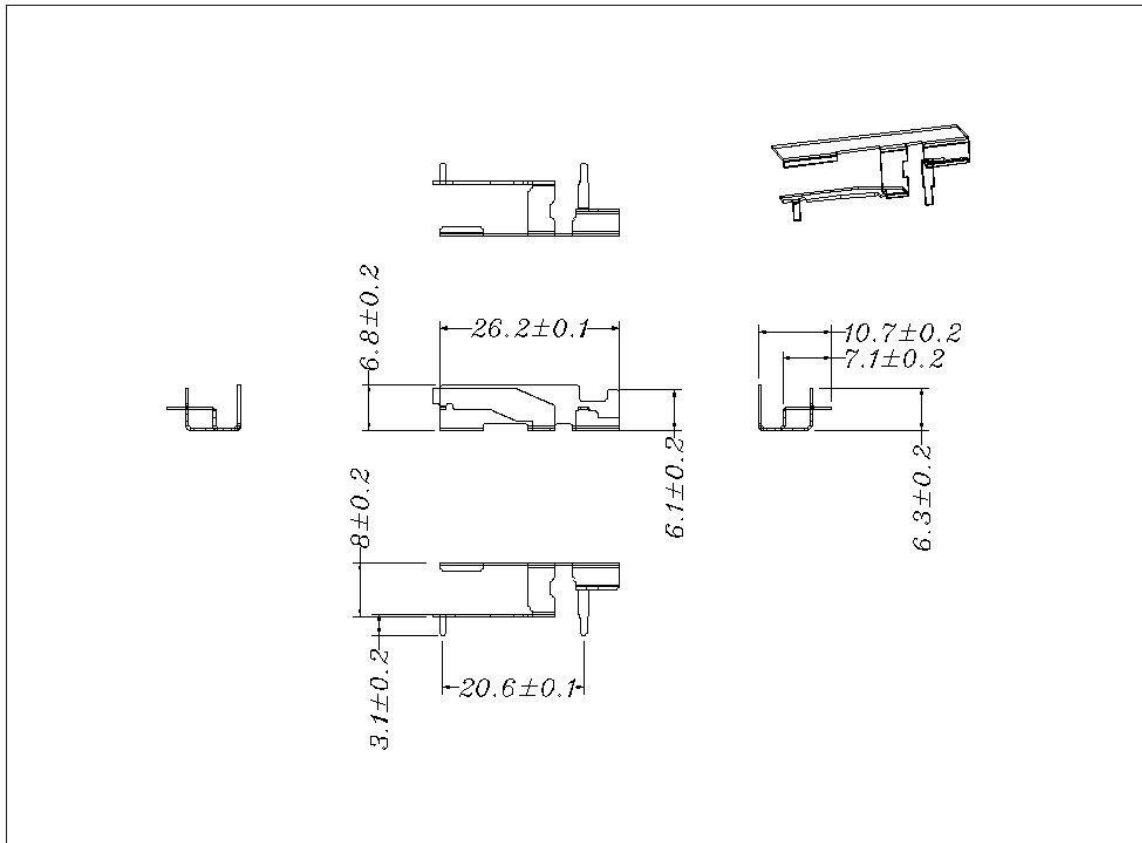

1. Return Loss and VSWR

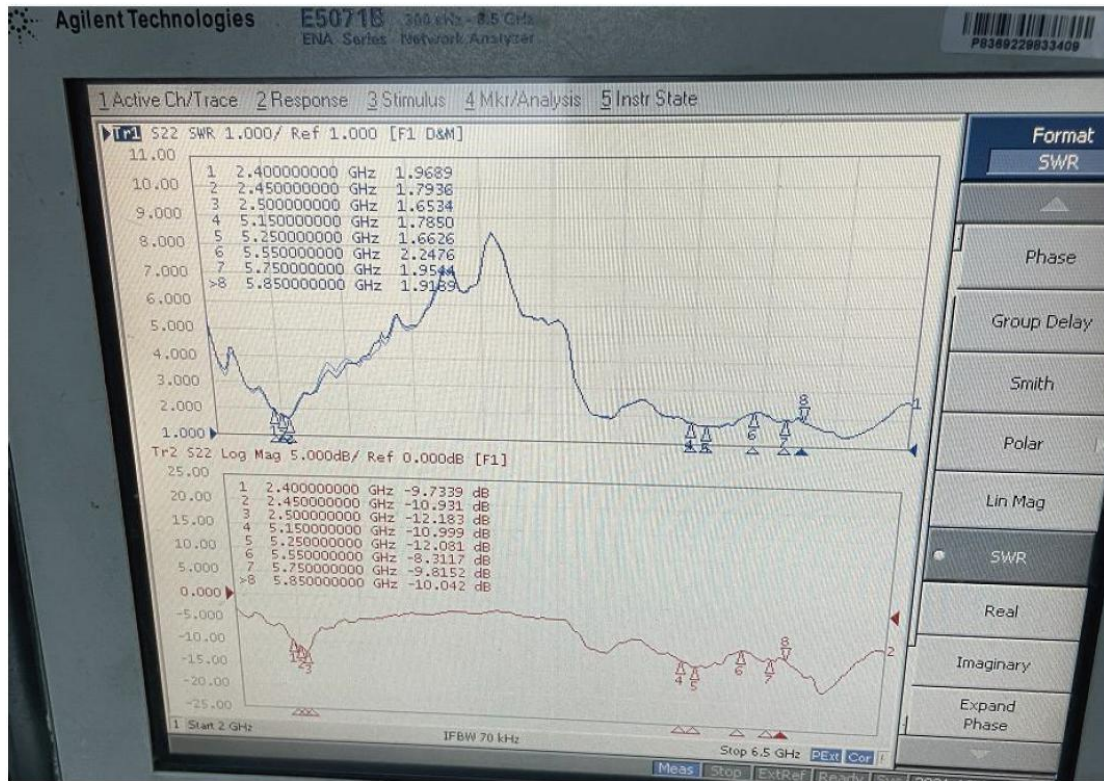

2. Efficiency and Gani

Frequency GHz	2.4	2.41	2.42	2.43	2.44	2.45	2.46	2.47	2.48	2.49	2.5
Efficiency%	41.81	43.98	4.40	43.69	45.81	42.85	44.98	43.87	42.21	45.92	42.31
Gani(dBi)	2.47	2.68	2.84	2.75	2.88	3.0	2.94	2.75	2.83	2.97	2.94

Frequency GHz	5.15	5.2	5.25	5.7	5.75	5.8	5.85
Efficiency%	61.09	62.81	64.71	63.53	61.52	55.85	51.64
Gani(dBi)	2.79	2.83	3.0	2.76	2.84	2.95	2.98

3.方向图(2.45G)

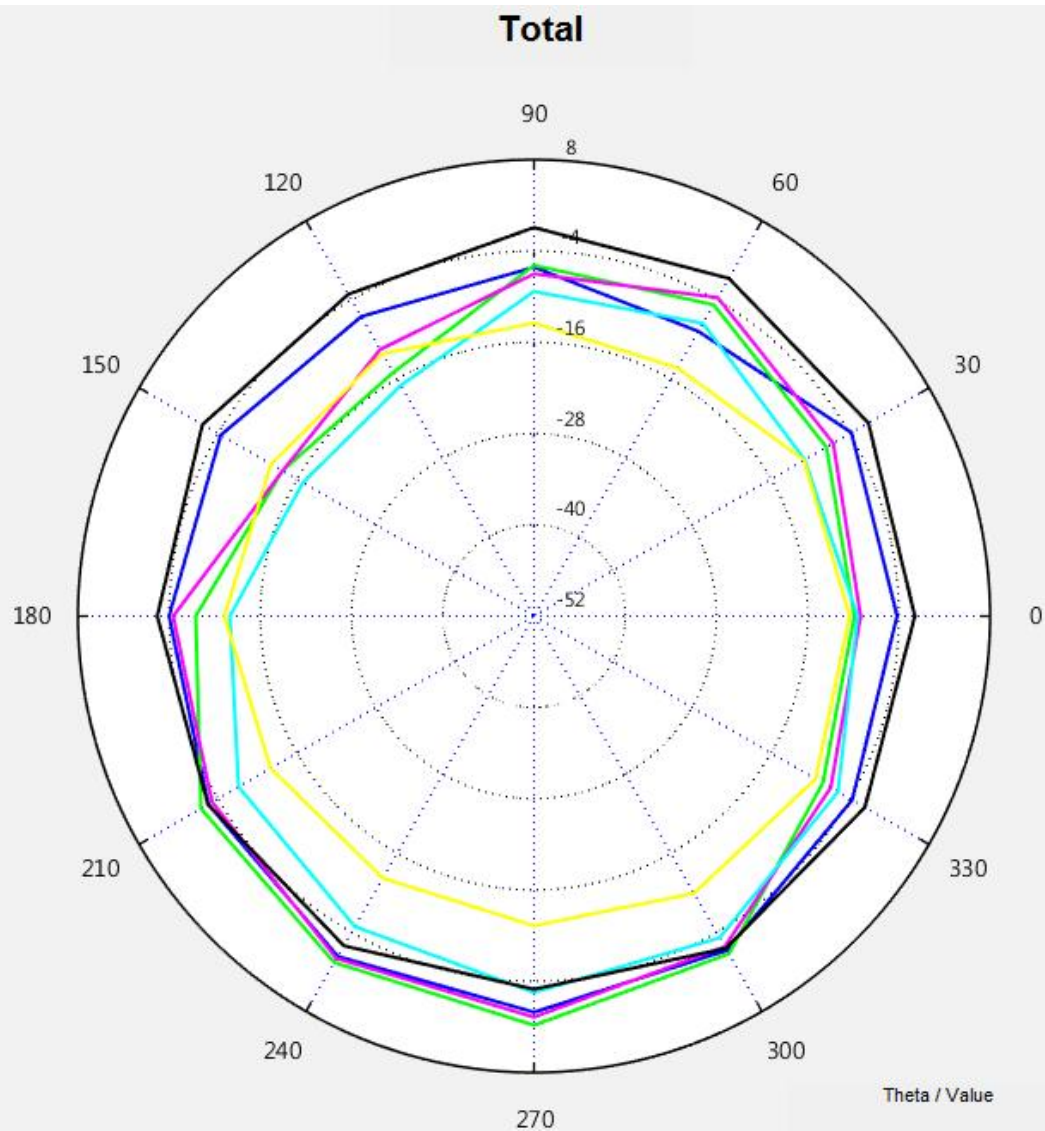
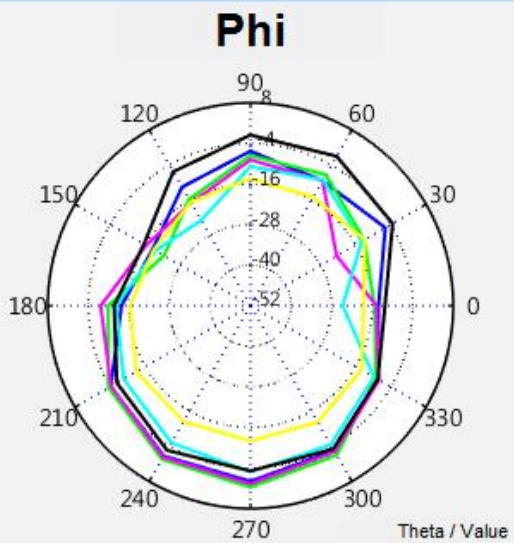
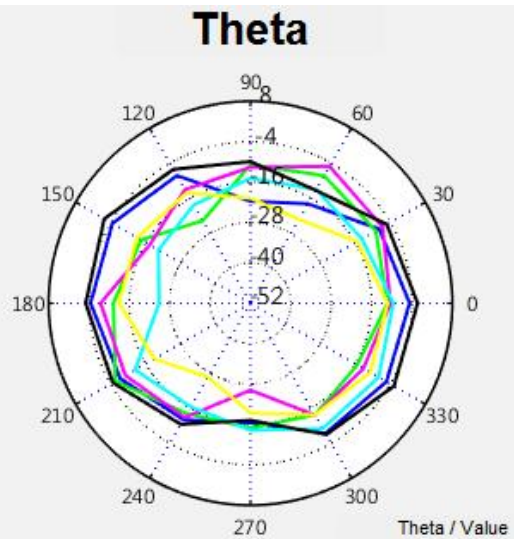

方向图(2.45G)

Theta

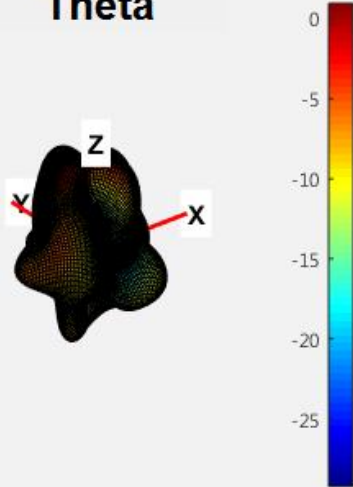

Phi

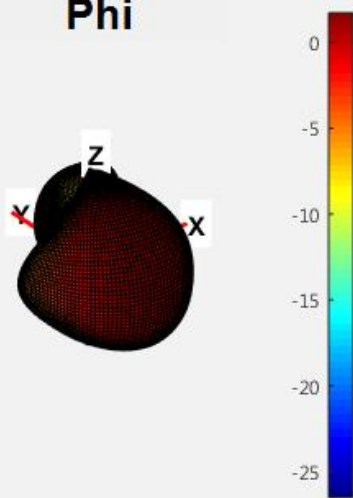

Total

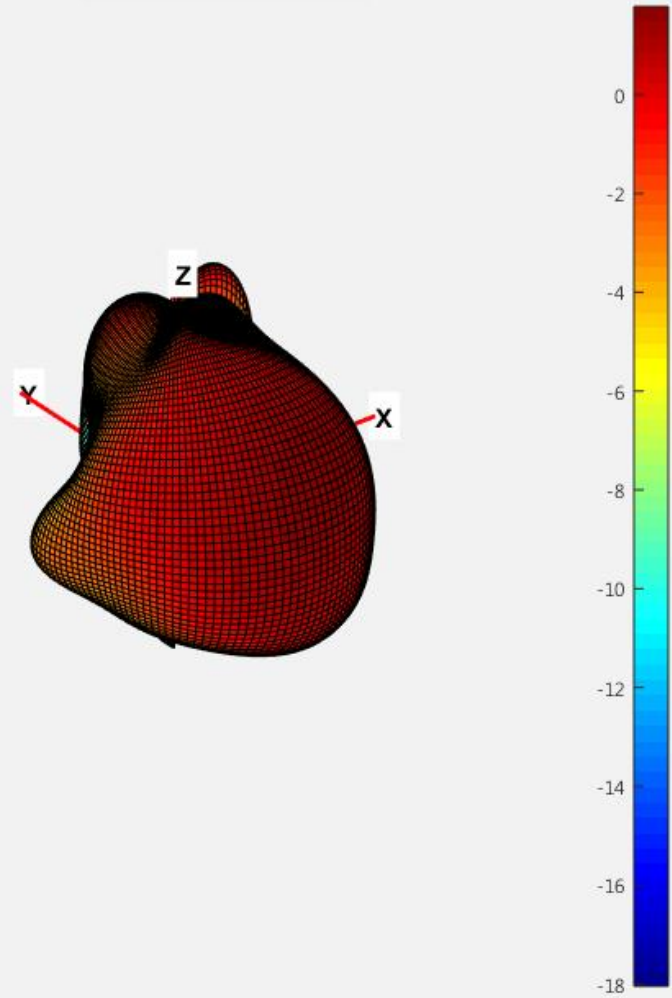

方向图(5.15G)

Theta

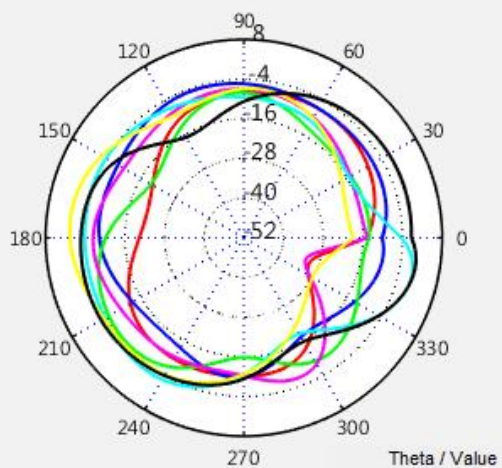

Phi

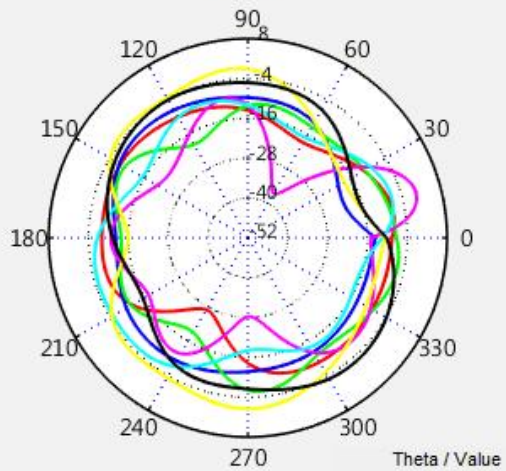

Total

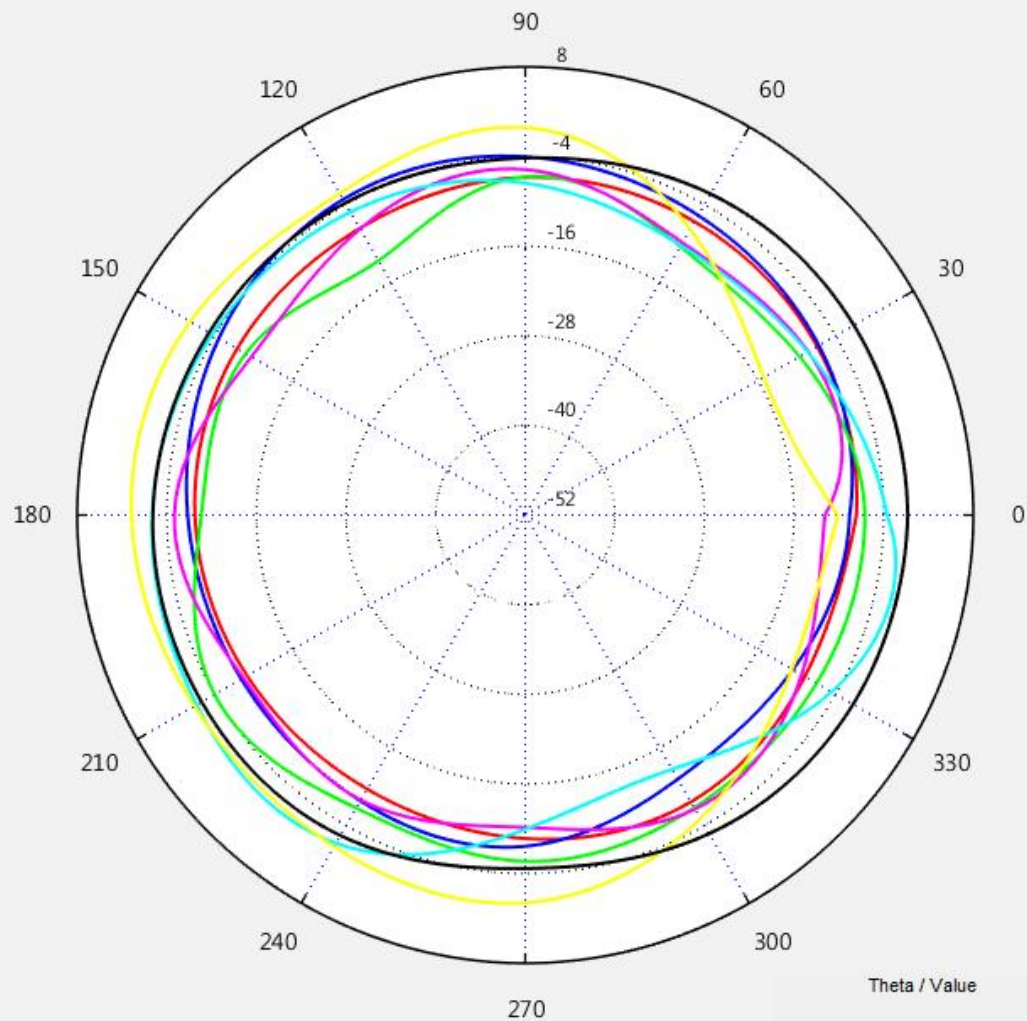

方向图(5.15G)

Theta

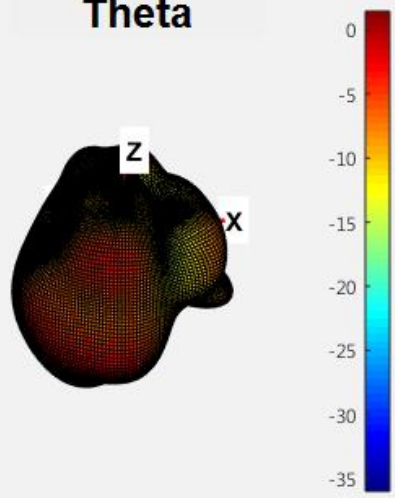

Total

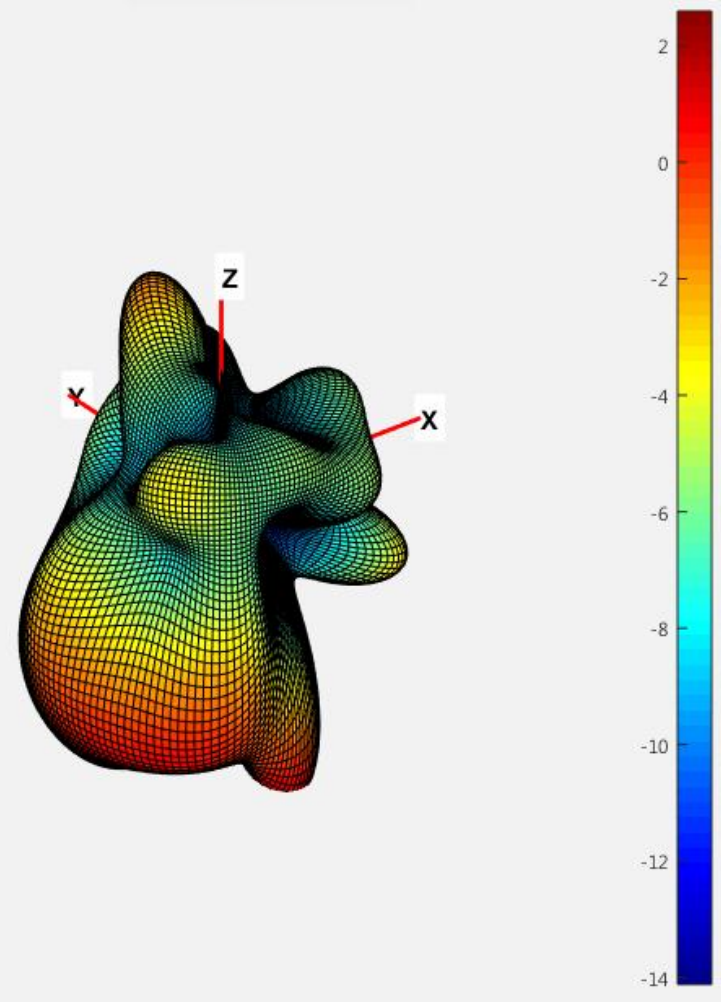

Phi

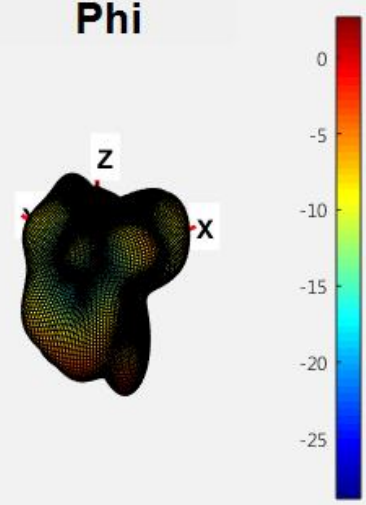

方向图(5.85G)

Theta

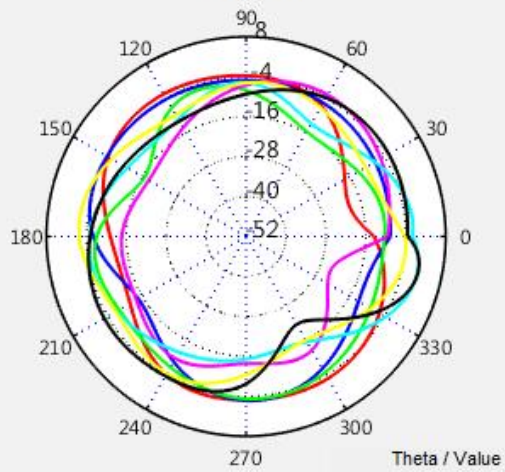

Phi

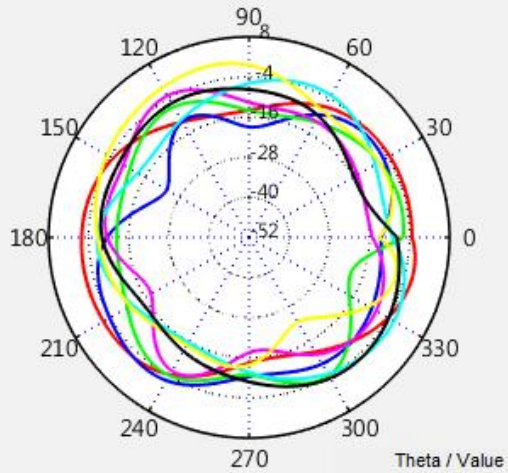

Total

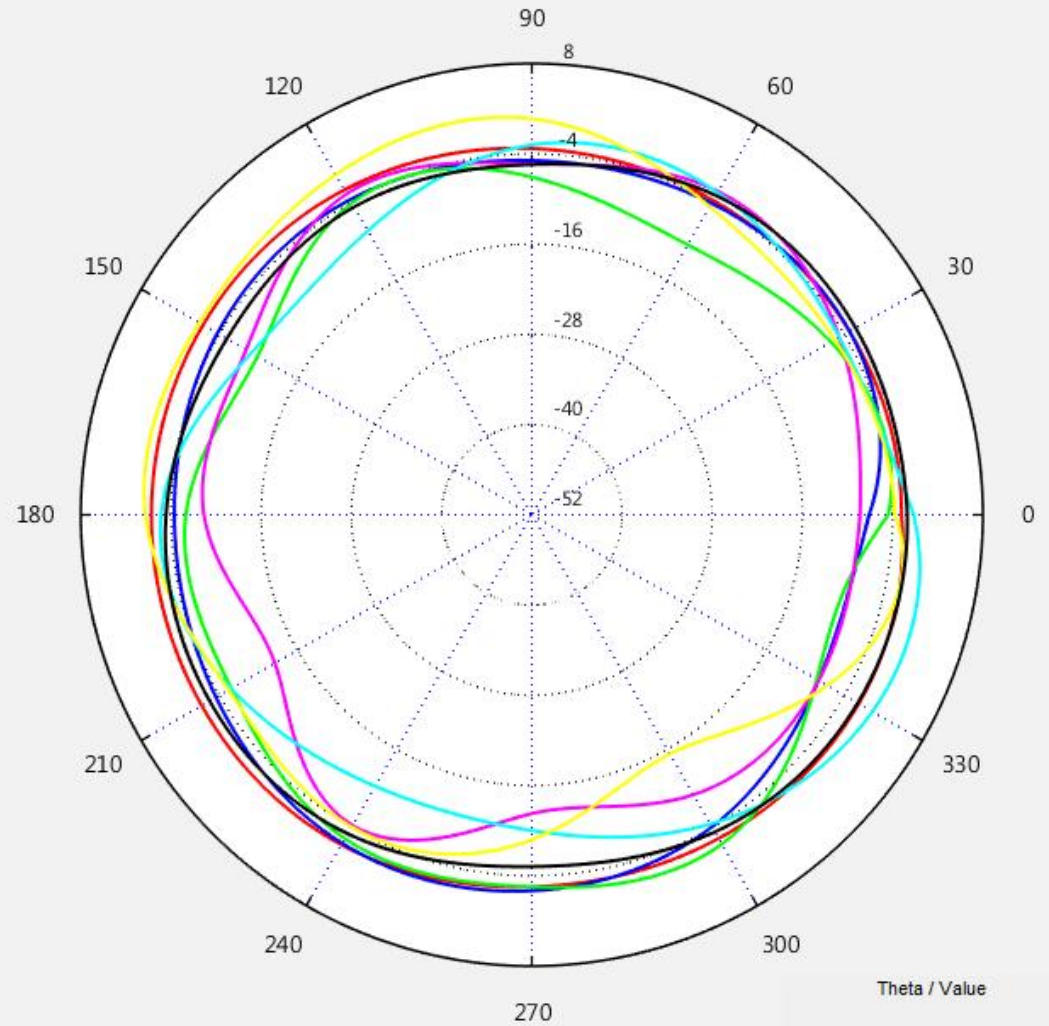

方向图(5.85G)

Theta

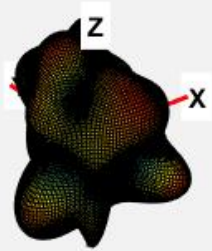

Phi

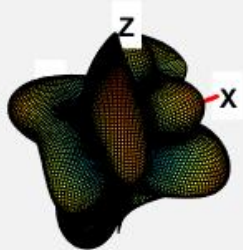

Total

