

# **Health Monitor**

HC-03U

## **User Manual**

File No.: QR-HC03U-C-F09

Revision: A/0

**Xiamen Linktop Technology Co., Ltd.**

## Table of Contents

01 IMPORTANT SAFETY INFORMATION .....	4
01.1 Symbols Bank.....	5
01.2 Environmental Requirements .....	5
01.3 Electromagnetic & RF Immunity.....	6
01.4 Static Electricity .....	6
01.5 Applicable People.....	7
01.6 Applicable Area .....	7
01.7 Human Exposure .....	7
01.8 Before Measuring .....	8
01.9 Self-Diagnosis .....	8
01.10 Inappropriate Storage.....	9
01.11 Care & Maintenance.....	9
01.12 Environmental Protection & Discard .....	9
01.13 Risk of Electrical Shock (AC Adapter Usage) .....	10
01.14 Battery Use & Safety .....	11
01.15 Display-Screen .....	11
02 DEVICE OVERVIEW .....	12
02.1 Know Your HC-03U .....	12
02.2 Unpacking & Checking .....	13
02.3 Device Connection .....	14
02.4 Intended Use .....	14
03 BEFORE MEASURING .....	14
03.1 Using the AC Adapter .....	14
03.2 Turn On/Off.....	16
03.3 Symbols & Items Bank .....	16
03.4 Display of Function Menu Page .....	17
03.5 Setting - Language .....	18
03.6 About Device .....	18
03.7 Factory Reset .....	19
04 MEASURING BLOOD PRESSURE .....	19
04.1 Overview.....	19
04.2 Safety Information .....	20
04.3 Display & Symbols Bank .....	21
04.4 Applying the Arm Cuff.....	21
04.5 For Accurate Measurement.....	22
04.6 Taking A Reading .....	24
04.7 Read the Blood Pressure Display .....	25
04.8 Illustrated Example of Measuring Blood Pressure .....	26
04.9 Troubleshooting.....	27
05 MEASURING FOREHEAD TEMPERATURE .....	27
05.1 Overview.....	27
05.2 Safety Information .....	27
05.3 Display & Symbols Bank .....	29
05.4 Taking A Reading .....	29
05.5 Illustrated Example of Measuring Forehead Temperature .....	31
05.6 Troubleshooting.....	31
06 AFTER MEASURING .....	31
06.1 Measurement Processing.....	31
06.2 View the Measuring Result.....	31
06.3 Check the History .....	32
06.4 Delete the History .....	32
07 CLEANING & DISINFECTING .....	32
07.1 The Difference Between Cleaning & Disinfecting .....	32
07.2 Safety Information .....	33
07.3 How to Clean and Disinfect the Device.....	33

07.4 How to Clean & Disinfect the Arm Cuff .....	34
08 STORAGE & MAINTENANCE .....	35
08.1 Storage .....	35
08.2 Safety Information .....	35
08.3 Maintenance .....	36
08.4 Discarding.....	36
09 SPECIFICATIONS.....	37
10 LIMITED WARRANTY .....	39
10.1 Manufacturer's Warranty .....	39
10.2 Limitations of Warranty.....	40
10.3 User Responsibility.....	40
10.4 What's NOT Covered by Warranty.....	41
10.5 Precautions for Transfer and Disposal.....	41
10.6 End User License Agreement for Software.....	42
11 IEC60601-1-2 EMC & RF STATEMENT .....	44
12. FCC Caution .....	48

## GENERAL DESCRIPTION

Thank you for using this Health Monitor HC-03U. Please read this User Manual carefully in order to use the medical device safely and correctly.



## DEVICE

The HC-03U device is a professional grade mobile medical device. The device was designed to capture and display vital sign results to healthcare providers and lay persons in home environment. The device is intended for spot-checking blood pressure, infrared temperature. The User Manual is a reference that does not substitute for training by a healthcare professional prior to use. These vital sign measurements can be stored on the device for display. The native device does not perform any decision support functions or provide alerts to the user.

HC-03U will collect the test requirements of body temperature, blood pressure and pulse rate information through infrared sensors, pressure sensors, and display. The users can observe the temperature, blood pressure, pulse rate and history measurement records on the device.

## 01 IMPORTANT SAFETY INFORMATION

- The user must carefully read and fully understand the instructions for use contained in the USER MANUAL before operating the device.
- To ensure proper operation of the device, and correct test results, the instructions and warnings contained in the USER MANUAL must be carefully reviewed and followed prior to and during operation of the device.
- Keep this USER MANUAL in the vicinity of the device so that it can be easily referenced.

The following symbols are referenced in the USER MANUAL, QUICK START GUIDE, LABELING, PACKING and must be fully reviewed and understood prior to use of the device:

### WARNINGS

Indicates a potentially hazardous situation which, if NOT avoided, could result in death or serious injury.

### CAUTION

Indicates a potentially hazardous situation which, if NOT avoided, may result in minor or moderate injury to the user or patient or damage to the device or other property.

### NOTES

Contain important information that may be overlooked or missed.



## CONSULT INSTRUCTIONS FOR USE

Indicates the need for the user to consult the instructions for use.

### 01.1 Symbols Bank

	Product serial number		Expiry date
	Manufacturer		Batch number
	Date of manufacture		Characters of "Catalogue number"
	European union authorization representative		Temperature Limit
	Part recycled separately from other waste		Characters of "Keep away from sunlight"
<b>IP22</b>	Protection grade		Characters of "Keep dry"
	Follow "Instructions for use"		Characters of "Do not use if package is damaged"
	BF type		Class II device
<b>CE</b> 0197	CE mark		Caution
<b>RoHS</b>	RoHS mark		

### 01.2 Environmental Requirements

#### Environment

Item	Operating	Storage
Temperature	41°F to 104°F / 5°C to 40°C (TEMP / NIBP)	-4 °F to 140°F / -20°C to 60°C
Relative humidity (non-condensing)	10%-85%	≤ 93%



#### WARNINGS

- Make sure that the operating environment of the device meets the specific requirements in this USER MANUAL. If NOT, it may result in damage to the device or cause an inaccurate reading.



#### CAUTION

- DO NOT measure with the device and accessories near heat sources such as in direct sunlight, near a fireplace or stove, and harsh environments.
- DO NOT use the device in the bathroom or moist circumstance.
- To ensure accurate readings, keep the device at room temperature for more than 30 Minutes before use.
- When the device and accessories are carried from a cold environment to a warm or humid environment, please DO NOT use it immediately. When the device is moved from one place to another, condensation may occur as a result of temperature or humidity difference.

### 01.3 Electromagnetic & RF Immunity

#### WARNINGS

- DO NOT expose or use the device in an MRI or CT environment. The induced current could cause burns to the user.
- DO NOT use the device in the presence of high-power appliances such as high voltage cables, X-ray machines, ultrasound equipment or a defibrillator.
- DO NOT use the device under the conditions of a strong electromagnetic field (e. g. medical RF equipment) that radiates interference signal or electrical fast transient/burst signal. Both of these may result in an operational failure.
- DO NOT use this device during defibrillation.

#### CAUTION

- Magnetic and electrical fields are capable of interfering with the proper performance of the device.
- Measurements can be affected by certain environmental conditions, errors in applying the sensor, and certain patient conditions. For this reason, make sure that all external devices operated in the vicinity of the equipment complies with this USER MANUAL EMC Requirements.
- This device may cause radio interference or may disrupt the operation or can be disrupted by external nearby equipment.
- Upper-frequency electrosurgical interference may cause inaccurate readings.
- During measurement, DO NOT use a cell phone or any other device that may cause electromagnetic interference, or emit electromagnetic fields, near the device. This may result in incorrect operation of the device.
- Use of this equipment adjacent to or stacked with other equipment should be avoided because it could result in improper operation. If such use is necessary, this equipment and the other equipment should be observed to verify that they are operating normally.

### 01.4 Static Electricity

#### WARNINGS

- DO NOT allow the electrodes of the device to come into contact with other conductive parts (including earth).
- DO NOT expose the device to electric shocks.
- DO NOT expose the device to any static electricity.

#### CAUTION

- To prevent electrostatic damage to the device, ensure that your body is free of static electricity before using the device. Static electricity can damage electronic components, contact with earthed objects or devices will discharge the energy that has built up and cause electrostatic discharge.

## 01.5 Applicable People

### WARNINGS

- Blood pressure measurement isn't used for neonatal or children under 12 years old.
- Body temperature measurement isn't used for neonatal or children under 5 years old.
- NOT for use on critically ill patients, patients in shock, dehydrated patients, or hyperosmolar patients.
- The device has NOT been tested for use on animals. DO NOT use on pets or any other animals.

### CAUTION

- The device should NOT be used by patients who are, or may become, pregnant as possible effects of this device on a fetus are unknown.
- The device is NOT intended for use by individuals who are disabled without supervision by an adult or qualified caregiver.
- Children shall use the device under guardians' monitor. Place the device in the position which children cannot touch since the device contains small components.

## 01.6 Applicable Area

### WARNINGS

- The device DOES NOT have an alarm that sounds when exceeding a limit.
- DO NOT use the device in critical situations or where alarms are required. In case of emergency, immediately contact your local emergency services.

### CAUTION

- The APP of device is applied for smartphone with Bluetooth 4.0, Android 4.3 or higher version. Please confirm your smartphone is complied with the requirements beforehand to avoid damaging the smartphone.

## 01.7 Human Exposure

- All materials used in the device that the patient will be in contact during use have been tested and found to comply with the requirements of ISO 10993 STANDARD.
- The software was developed in compliance with IEC60601-1-4.
- All LINKTOP HC-03U devices are designed to comply with rules and regulations in locations they are sold and are labeled as required.

### WARNINGS

- To minimize potential skin irritation, DO NOT place the device sensor over broken or damaged skin.
- DO NOT place the device on swollen or tender tissue or broken or damaged skin.

### CAUTION

- Discontinue use and consult your healthcare provider if your skin is irritated or inflamed during use of the device.

## 01.8 Before Measuring



### WARNINGS

- Check the device to make sure that there is NO visible damage that may affect the user's safety and measurement performance. Stop using the device if it is damaged.
- Chemicals from a broken LED panel are toxic when ingested. Use caution when the device has a broken display screen.
- DO NOT operate the device if it is wet or in a wet or moist environment.
- DO NOT take measurements more than necessary.
- Any data erased from the device CANNOT be recovered.
- DO NOT use the device when charging.



### CAUTION

- DO NOT measure in a moving vehicle or during physical activity.
- DO NOT operate the device while using other electrical devices.
- To obtain accurate results, the device should be used in a quiet and comfortable environment.
- Please check and ensure that the batteries are working properly.
- DO NOT have low battery or dead battery warning message before use the device.
- When the device is in use, ensure that the batteries are sufficiently charged to avoid startup abnormalities or inaccurate data measurements.
- Remain still during measurement. DO NOT move your body or arms.
- DO NOT speak, talk to avoid affecting the accuracy of the measurement.
- The device may NOT work for all patients. If you are unable to achieve stable readings, please discontinue use and discuss with your healthcare provider.

## 01.9 Self-Diagnosis



### WARNINGS

- All medical concerns and issues should be discussed with your healthcare provider. The device is intended ONLY as an adjunct in patient assessment.
- The measurement of healthcare data using the device DOES NOT represent or substitute for a healthcare provider's medical examination.
- You should NOT interpret the measurement results yourself.
- DO NOT attempt self-diagnosis or self-treatment based on the measurement results and analysis, self-diagnosis or self-treatment may lead to deterioration in your condition.
- DO NOT change your therapy or treatment without independent confirmation from your healthcare provider following a complete medical examination.
- Always consult your healthcare provider before beginning or modifying any exercise program.
- This device is NOT intended for treatment.



### CAUTION

- The device allows you to monitor healthcare data ONLY as referenced in this USER MANUAL.
- The data and messages displayed on the device are for reference ONLY and CANNOT be directly used for diagnostic interpretation. It must be used in conjunction your healthcare provider who can fully assess your healthcare needs and symptoms.
- The device may NOT work for all patients.
- The values displayed by the device are the values at the time of measurement. Medical conditions can change suddenly.



- If measured values exceed the normal range or you are concerned with any reading obtained by the device, please contact a healthcare professional or healthcare provider immediately to obtain specific healthcare advice.
- If you notice any change in your condition, consult your healthcare provider, regardless of the measurement results.
- If you are taking medication, consult your healthcare provider to determine the most appropriate time to measure your physiological data.
- NEVER change prescribed medication without consulting your healthcare provider.
- The device is NOT a substitute for seeking medical attention.
- If you believe you are experiencing any adverse medical event, seek immediate medical attention.

### 01.10 Inappropriate Storage



#### WARNINGS

- **CHOKING HAZARD**  
The device may contain small parts that may cause a choking hazard if swallowed by infants. Keep away from children under the age of 3 Years.



#### CAUTION

- The device is NOT a toy. Children must be supervised around the device and the device should be stored in a secure location.
- DO NOT stack with other equipment as it could result in improper operation.
- DO NOT expose the device to strong shocks or vibrations.
- Avoid dropping, stepping on, or shaking the device.
- For routine device storage, please refer to Chapter 08 "Storage & Maintenance" as indicated in this USER MANUAL.

### 01.11 Care & Maintenance



#### WARNINGS

- DO NOT dismantle the device as this may result in damage or malfunctions.



#### CAUTION

- It is recommended that the device be inspected before use to make sure that there is NO visible damage that may impact safety and performance. Discontinue use of the device if damaged.
- Parts that are broken, worn, distorted or contaminated should be replaced immediately. Should any repair or replacement become necessary, we recommend contact your LINKTOP representative or call 0086-592-3691601.
- For routine care & maintenance of the device, please refer to Chapter 08 "Storage & Maintenance" in this USER MANUAL.

### 01.12 Environmental Protection & Discard



#### WARNINGS

- DO NOT dispose of in fire, contains lithium battery that may explode.
- DO NOT dispose of the device with household waste.
- DO NOT dispose of this device as "UNSORTED MUNICIPAL WASTE." The disposal of scrap device and its accessories and packing (including battery, plastic bags, foams, and paper boxes) should follow the local laws and regulations.
- For environmental reasons, unlawful disposal may cause environmental pollution.

- For routine discard, please refer to Section 08.4 "Discarding" in this USER MANUAL.

### 01.13 Risk of Electrical Shock (AC Adapter Usage)



#### WARNINGS

##### UL CERTIFIED CHARGER

- The Charger for this device should meet applicable UL Safety Requirements. Please adhere to the following safety instructions per UL Guidelines:

FAILURE TO FOLLOW THE INSTRUCTIONS OUTLINED MAY LEAD SERIOUS PERSONAL INJURY AND POSSIBLE PROPERTY DAMAGE. IMPORTANT SAFETY INSTRUCTIONS - SAVE THESE INSTRUCTIONS.

##### DANGER

- To reduce the risk of fire or electric shock, carefully follow these instructions.
- For connection to a supply NOT in North America, use an attachment plug adaptor of the proper configuration for the power outlet.
- This power unit is intended to be correctly oriented in a vertical or horizontal or floor mount position.
- If the USB power cable is damaged or the plug loosens, stop using the cable at once as continued use may result in an electric shock, short circuit of the charger, or a fire.
- DO NOT use the AC adapter if the device or the power cord is damaged. Turn off the power and unplug the power cord immediately.
- DO NOT plug or unplug the power cord into the electrical outlet with wet hands.
- DO NOT overload power outlets. Plug the device into the appropriate voltage outlet.
- DO NOT use with outlet adaptors.
- When charging, ensure the charger is plugged into an AC main plug that is in close proximity to the device. The charger must be easy to access.
- Connect charging dock to the recommended charger and the power supply (110~240V/50~60Hz/0.5A max).
- Use ONLY the original AC adapter designed for the device. Use of unsupported adapters may damage and/or maybe hazardous to the device. An improper power voltage may cause a fire or a malfunction of the charger.
- DO NOT use a power cable that is NOT approved or supplied by LINKTOP.
- DO NOT connect the charge station to any power source or external equipment other than described in this USER MANUAL.
- DO NOT disassemble, crush, puncture, shred, or otherwise attempt to modify the battery.
- DO NOT put pressure on the battery as this can cause leakage or an internal short-circuit, resulting in overheating, fire or explosion.
- DO NOT let the device or battery come in contact with liquids.
- Liquids can get into the device's circuits, leading to corrosion posing a safety hazard.
- Read and follow the "Important information regarding Electro Magnetic Compatibility (EMC)".



##### CAUTION

- Fully insert the power plug.
- The USB power cable is considered as a separate device to the charging adapter.
- Output rating of charger 5.0V 500mA-2.0A
- The charging process takes approximately 20-90 minutes.

When handling the power cord, observe the following:

- Wipe any dust off the power plug.
- Disconnect the power plug if the product will NOT be used for an extended period.
- Disconnect the power plug when performing maintenance of the device.

- When disconnecting the power plug, DO NOT pull the power cord. Be sure to remove by holding the power plug.

When handling the power cord, take care NOT to do the following:

- DO NOT damage.
- DO NOT tamper with it.
- DO NOT twist.
- DO NOT pinch.
- DO NOT break it.
- DO NOT forcibly bend or pull.
- DO NOT bundle during use.
- DO NOT place under heavy objects.

To avoid inadvertent disconnection, route all cables to prevent a stumbling hazard. Wrap and secure excess cabling to avoid a risk of entanglement or strangulation by the users.

#### 01.14 Battery Use & Safety

##### **WARNINGS**

- DO NOT place your battery in or near a heat source. Excessive heating can damage the device or the battery and could cause the device or the battery to explode.
- DO NOT dry a wet or damp battery with an appliance or heat source such as a microwave oven, hairdryer, iron, or radiator.
- Avoid leaving your device in your car in high temperatures.
- Handle and store batteries properly to avoid injury or damage. Most battery issues arise from improper handling of batteries and the continued use of damaged batteries.
- DO NOT dispose of the device or the battery in a fire. The device or the battery may explode when overheated.
- DO NOT handle a damaged or leaking battery. DO NOT let leaking battery fluid come in contact with your eyes, skin or clothing.
- Avoid dropping the device. Dropping the device or the battery, especially on a hard surface, can damage the device and battery.
- NEVER use any battery that is damaged in any way.
- DO NOT allow the battery to touch metal objects. Accidental short-circuiting can occur when a metallic object (coin, key, jewelry, clip, or pen) causes a direct connection between the "+" and "-" terminals of the battery (metal strips on the battery).
- Short-circuiting the terminals may damage the battery or the device causing short-circuiting. Use ONLY LINKTOP approved batteries and recharge your battery ONLY with LINKTOP approved chargers specifically designed for your device.
- Use of a non- LINKTOP - approved battery or charger may present a risk of fire, explosion, leakage, or other hazards.
- LINKTOP's warranty DOES NOT cover damage to the device caused by non - LINKTOP -approved batteries.
- DO NOT use incompatible batteries and chargers. Consumers should purchase manufacturer or carrier-recommended products and accessories.
- Misuse or use of incompatible batteries and charging devices could result in damage to the device and a possible risk of fire, explosion, or leakage, leading to serious injuries, damages to your device, or other serious hazards.

#### 01.15 Display-Screen

##### **WARNINGS** **WARNING REGARDING DISPLAY**

The display on the device is a 0.96-inch 64x3x128 resolution OLED panel and could break if the device is dropped or receives a significant impact. DO NOT use if the screen is broken or cracked as this could cause injury.

## 02 DEVICE OVERVIEW

### 02.1 Know Your HC-03U

#### a. Device

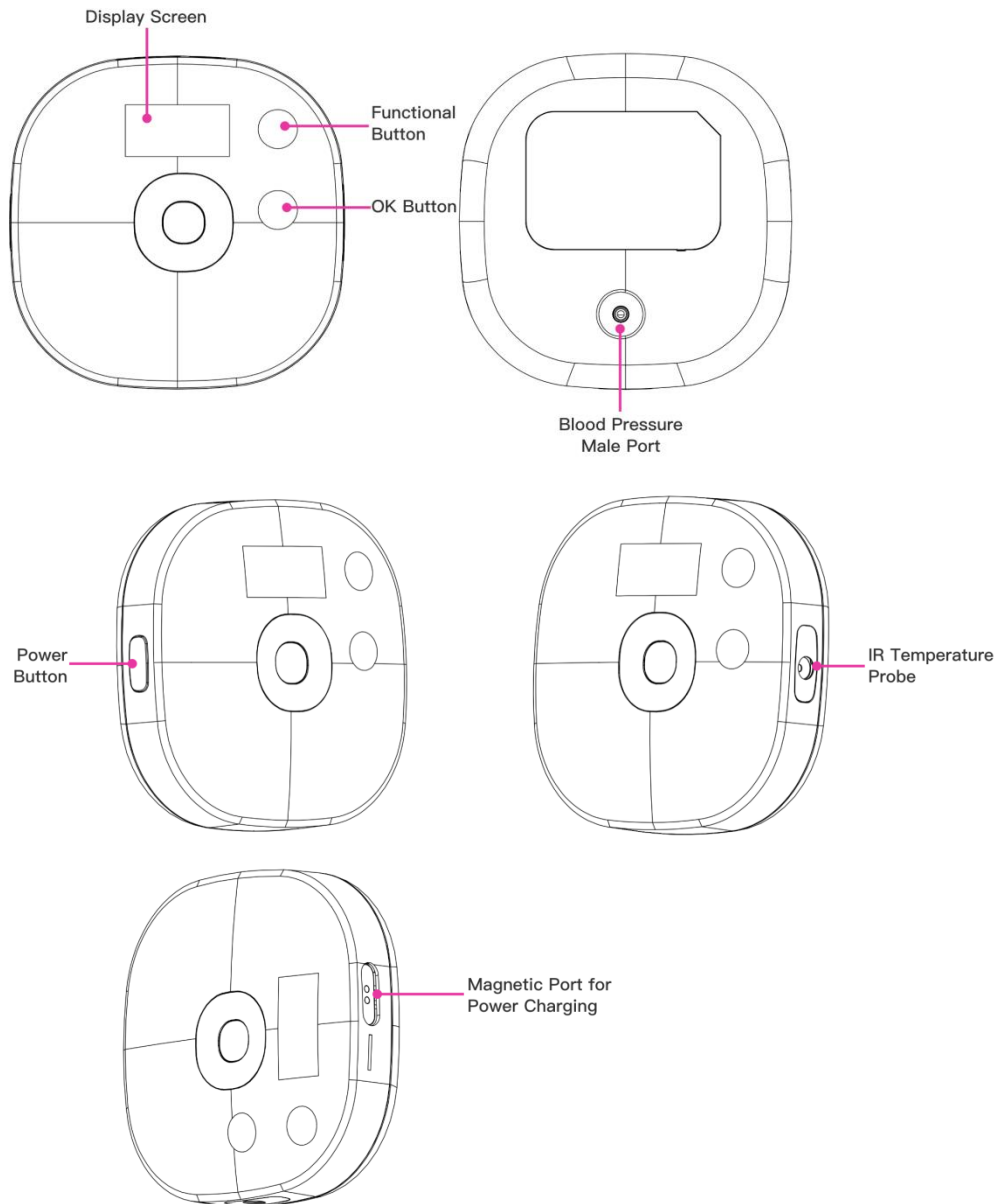

#### b. Arm Cuff

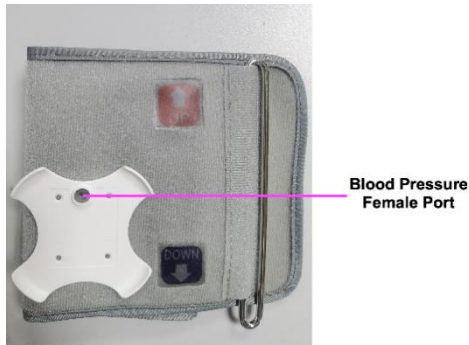

**CAUTION**

To ensure accurate measurements, LINKTOP recommends annual replacement of the arm cuff.

**c. USB Cable**



**d. User Manual**



**02.2 Unpacking & Checking**

Open the package. Remove the device and all accessories. The following parts are provided in the package:

ITEM	QTY	CHECK
a. HC-03U Health Monitor	1	
b. Cuff	1	
c. USB Cable	1	
d. User Manual	1	

**CAUTION**

If any of these items are missing from your kit, contact LINKTOP.

### 02.3 Device Connection

The device supports Bluetooth function, which can be used for OTA to upgrade the software of the device, and can support third-party software connection to view the measurement results.

If you need to download the APP with these functions, please log in <https://www.linktop.com/>, click "download center" to download the APP, then:

- Press power button and hold 3 seconds to power on the device.
- Open the APP to search and connect to the device with appearing of Bluetooth connection icon and prompt " Connected " on device.
- If the device shows the Bluetooth not connected icon and prompts " Disconnect ", enter the APP to set up the connection manually.

#### CAUTION

##### Cautions for using APP

- Confirm the system specification in mobile phone comply with the requirements before downloading the APP.
- In order to set up the automatic connection between mobile phone and device, the device shall be powered on before logging in APP.
- Most of malfunctions could be solves after rebooting device and APP.

#### Trouble shooting

Malfunctions	Reason	Solution
Failure of download APP	Mobile phone does not satisfy the requirements	Check the version of Bluetooth and system of mobile phone.
Failure of automatic connection	Wrong operation sequence	Power on the device firstly, then log in APP. Or connect manually.
Failure of connection or finding the device	Weak sensitivity of Bluetooth of mobile hone	Restart the device and re-log in the App.

### 02.4 Intended Use

HC-03U is intended to be used for measuring, displaying and storing of body temperature, blood pressure and pulse rate in the home or in healthcare facilities.

The device obtains the body temperature by measuring the forehead area.

The device obtains the blood pressure by measuring the upper arm site.

The device cannot be used for self-diagnosis.

This product should not encourage self-medication or adaptation of the treatment. Must consult the doctor if the patient has any questions or he believes he has abnormal measurements.

Blood pressure measurement isn't used for neonatal or children under 12 years old.

Body temperature measurement isn't used for neonatal or children under 5 years old.

## 03 BEFORE MEASURING

### 03.1 Using the AC Adapter

#### IMPORTANT SAFETY INSTRUCTIONS (Save These Instructions)

TO REDUCE THE RISK OF FIRE OR ELECTRIC SHOCK, CAREFULLY FOLLOW THESE INSTRUCTIONS.

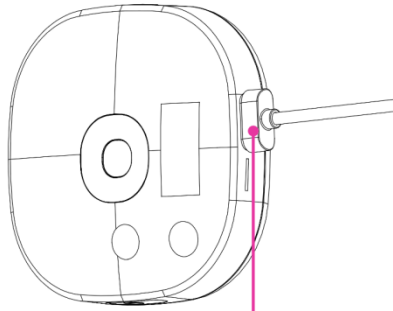

1. Connect the **Magnetic Charging Cable** to the charging port of the device

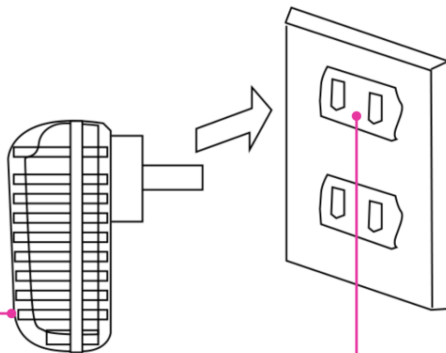

2. Insert the USB connector of the **Magnetic Charging Cable** into the USB receiver of the **AC Adapter**.

3. Plug the **AC Adapter** into an electrical outlet.

### **WARNINGS**

- The power unit (AC Adapter) is intended to be correctly used in a vertical or floor mount position.
- Use **ONLY** the Charger that should meets applicable UL Safety Requirements
- If the AC Adapter is disconnected while the device is being used, the measurement results will **NOT** be deleted.

### **CAUTION**

- Use **ONLY** LINKTOP authorized parts and accessories.
- Parts and accessories **NOT** approved for use with the device may damage the device.
- To disconnect the AC Adapter, unplug the AC Adapter from the electrical outlet first and then remove the Cable Plug from the device.

## 03.2 Turn On/Off

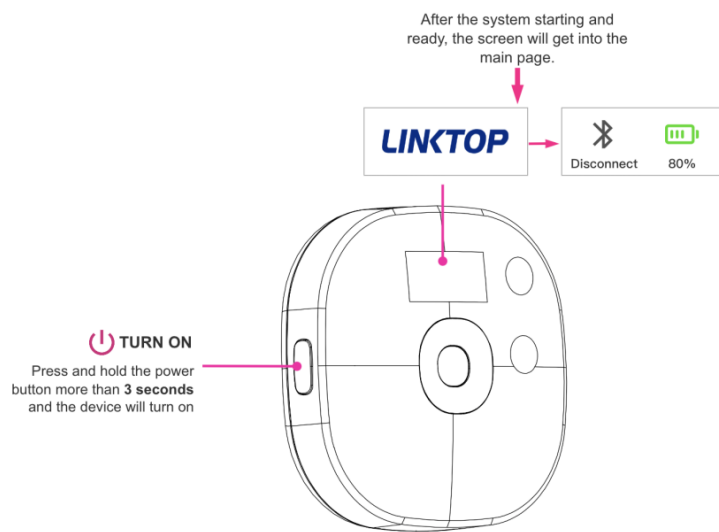

## 03.3 Symbols & Items Bank

### Display of Home page

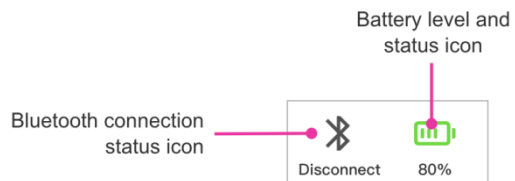

### Symbols

 Battery Charging

 Battery Level

 Battery Low

 Battery Dead

 Bluetooth Disconnect

 Bluetooth Connected



### 03.4 Display of Function Menu Page

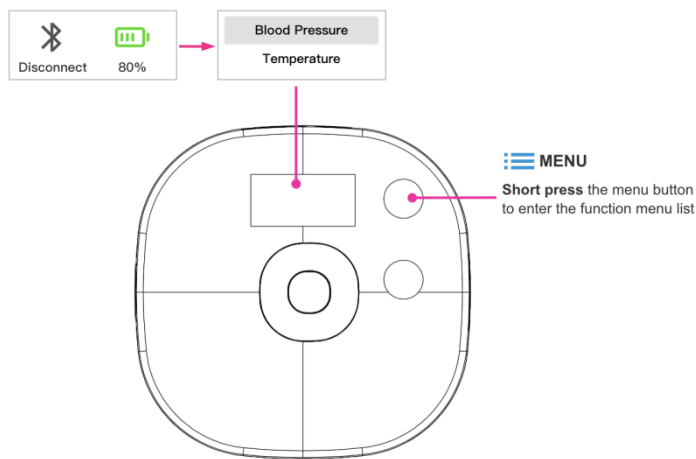

### Function Menu Page

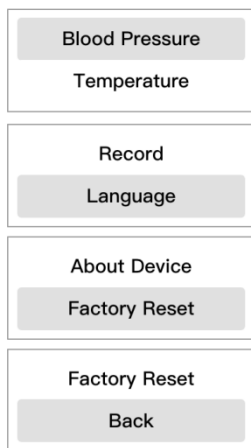

- Home Page:  
Short press the Function button to enter the function menu page.
- Function menu Page:  
Short press the function button to switch the cursor and select the menu.  
Including:
  - (1) Blood Pressure: enter the function menu page for blood pressure measurement.
  - (2) Body temperature: enter the function menu page for forehead temperature measurement.
  - (3) Record: keep the records of blood pressure and body temperature measurement.
  - (4) Language: enter the function menu page for switch the device display language.
  - (5) About Device: view the device information.
  - (6) Factory Reset: factory reset the device.
  - (7) Back: Return to the standby page.

### 03.5 Setting - Language

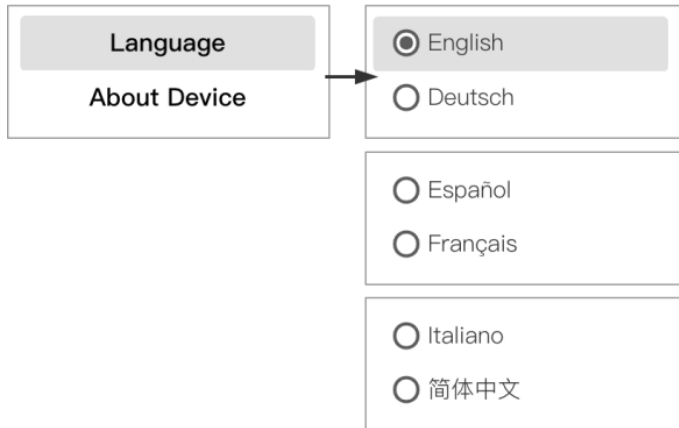

1. In the home page, short press the function button to enter the function menu.
2. Select the Language menu, and short press the confirmation Button to enter the language page.
3. Short press the function button to switch the cursor to select a language.
4. Short press confirm button to return to the function menu page.

#### CAUTION

The device may be used in **English, German, Spanish, French, Italian, Simplified Chinese**. The device default language is **English**.

### 03.6 About Device

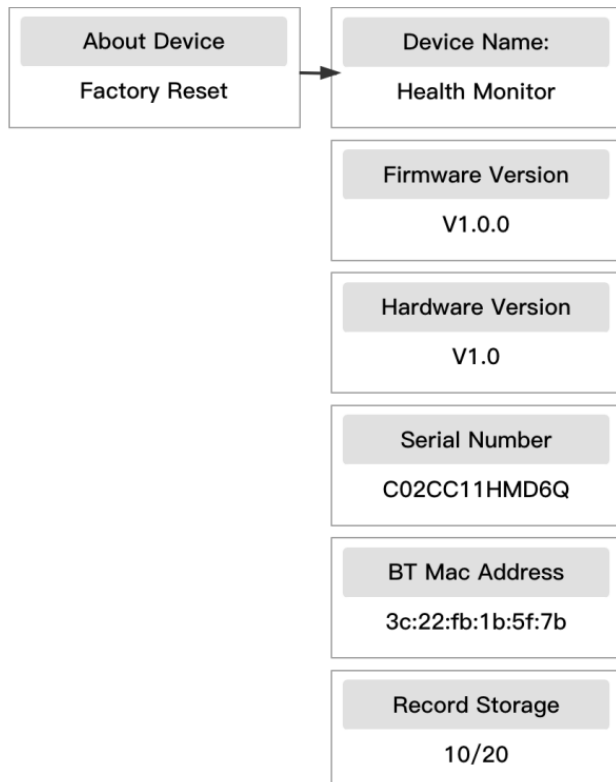

1. In the home page, short press the function button to enter the function menu.
2. Select the About Device menu, and short press the confirmation Button to enter the page.

3. Press the function Button to switch the cursor to view device information.
4. Short press confirm button to return to the function menu page.

### 03.7 Factory Reset

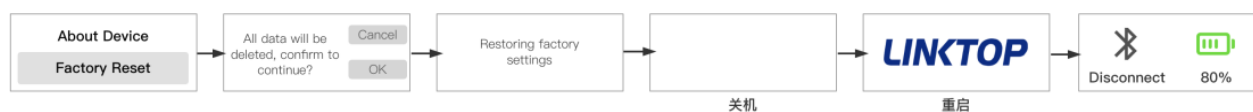

1. In the home page, short press the function button to enter the function menu.
2. Select the Factory Reset, and short press the confirmation Button to prepare to restore the factory settings.
3. An pop-up prompt 『All data will be deleted, confirm to continue?』 .
4. Short press the confirmation button to confirm the resumption of factory settings

## 04 MEASURING BLOOD PRESSURE

### 04.1 Overview

This device uses the Oscillometric Measuring Method to measure non-invasive blood pressure (NIBP).

#### Measurement Range:

Cuff range	22~35 cm
Pressure range	0~300mmHg
SYS Measurement range	60~230mmHg
DIA Measurement range	40~130mmHg
PR range	40~180bPm

### Color coded and audible Information

The device is designed to give you an easy indication reading with color measuring results which illuminate after taking the reading:

	RESULTS COLOR	MEANING
SYS 91 ~ 139 mmHg DIA 61 ~ 89 mmHg	Green	Acceptable
Other readings	Red	Consult a healthcare provider

### 04.2 Safety Information

#### WARNINGS

- DO NOT measure with the environment temperatures below 41°F (+5°C), or above 104°F (+40°C).
- DO NOT measure with humidity below 10% or above 85%.
- The device and Blood Pressure function are NOT designed to be used by anyone less than 12 years of age.
- DO NOT use the device on children or disabled individuals without supervision.
- NOT for use on critically ill patients, patients in shock, dehydrated patients, or hyperosmolar patients.
- DO NOT use in case of potentially life-threatening arrhythmias requiring hospitalization, or when real-time or in-patient monitoring should be prescribed.
- CONSULT your healthcare provider before using the device:
  - If you have had a mastectomy.
  - If you suffer from an irregular heartbeat.
- DO NOT use the device on an injured arm or the arm under medical treatment.
- DO NOT apply the arm cuff to an arm on an intravenous drip or during a blood transfusion.
- If the arm cuff fails to deflate when pressures exceed 300mmHg, detach the arm cuff and press the "STOP BUTTON" to stop inflation.
- DO NOT allow the arm to be squeezed by the arm cuff for extended periods. If the arm cuff continues to inflate, there is a risk of arm injury.
- DO NOT disassemble the device or arm cuff. This may cause an inaccurate reading or injury.
- This device is NOT suitable for continuous monitoring during medical emergencies or operations.
- DO NOT use the device for any purpose other than measuring blood pressure or other function in this device.
- This device is NOT intended for treatment.
- If you are taking medication, consult your healthcare provider to determine the most appropriate time to measure your blood pressure. NEVER change prescribed medication without first consulting your healthcare provider.
- Always consult your healthcare provider before beginning or modifying any exercise program.

#### CAUTION

- DO NOT use the device in the bathroom or wet environments.
- The Heart Rate measurement may include the pacemaker rate during occurrences of cardiac arrest or some arrhythmias since this device has NO capability of pacemaker pulse inhibition. DO NOT rely entirely upon the Heart Rate reading in this situation and consult your healthcare provider regarding the appropriate use of this device.
- Use ONLY the approved arm cuff for this device. The use of other cuffs may result in incorrect measurement results or injury.



## NOTES

- Complicating factors such as common Arrhythmias, Ventricular, Premature Beats, Atrial Fibrillation, Arterial Sclerosis, Poor Perfusion, Diabetes, Age, Pregnancy, Preeclampsia or Renal Disease can affect the performance of the automated sphygmomanometer and/or its blood pressure reading.
- For patients with high mental anxiety, self-measurement of blood pressure is NOT recommended.
- DO NOT use on people with sensitive skin or allergies. This may result in exanthema, skin irritation, or eczema.

### 04.3 Display & Symbols Bank

#### ➤ Normal measurement



#### ➤ Disruption measurement



#### ➤ Air leakage in measurement

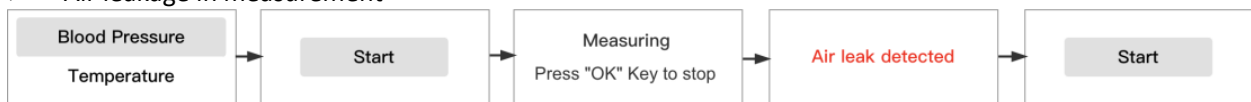

#### ➤ Blood pressure result

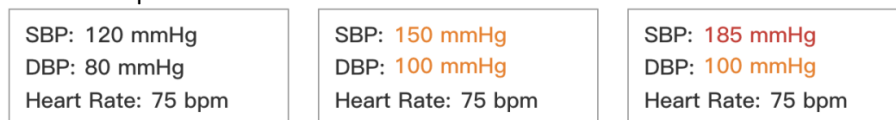

#### ➤ Heart rate result

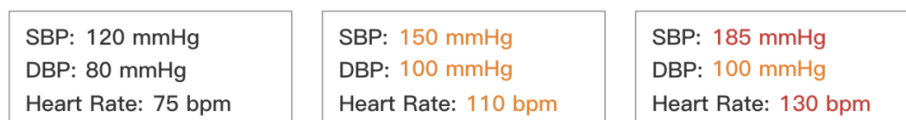

### 04.4 Applying the Arm Cuff

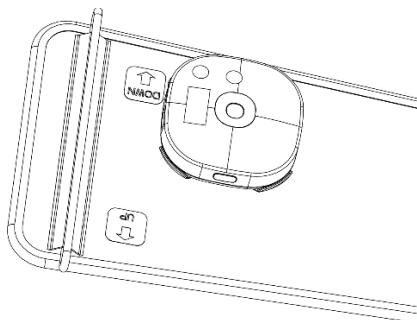

1. Install the equipment on the cuff.

2. Ideally, remove close-fitting garments from the upper arm.
3. Apply around the upper arm.
4. Wrap the arm cuff strap.

### CAUTION

- ⚠️ • Apply the arm cuff to your right upper arm so the arrow and the air tube runs along the inside of your elbow. The bottom of the arm cuff should be approximately  $\frac{1}{2}$  inch (or 1.5 ~ 2 cm) above your elbow.
- DO NOT place the arm cuff over thick clothes. When rolling up a sleeve, ensure it DOES NOT cause constriction of the blood flow in the upper arm.
- The vent outlet must tighten the equipment to cut off the air flow into the cuff.
- The arrow should be centered on the inside of the arm and aligned with your middle finger.
- DO NOT wrap clothes into the arm cuff strap as this may affect the accuracy of measurement.
- DO NOT wrap the arm cuff too tightly. It should be loose enough for two-finger insertion.

### 04.5 For Accurate Measurement

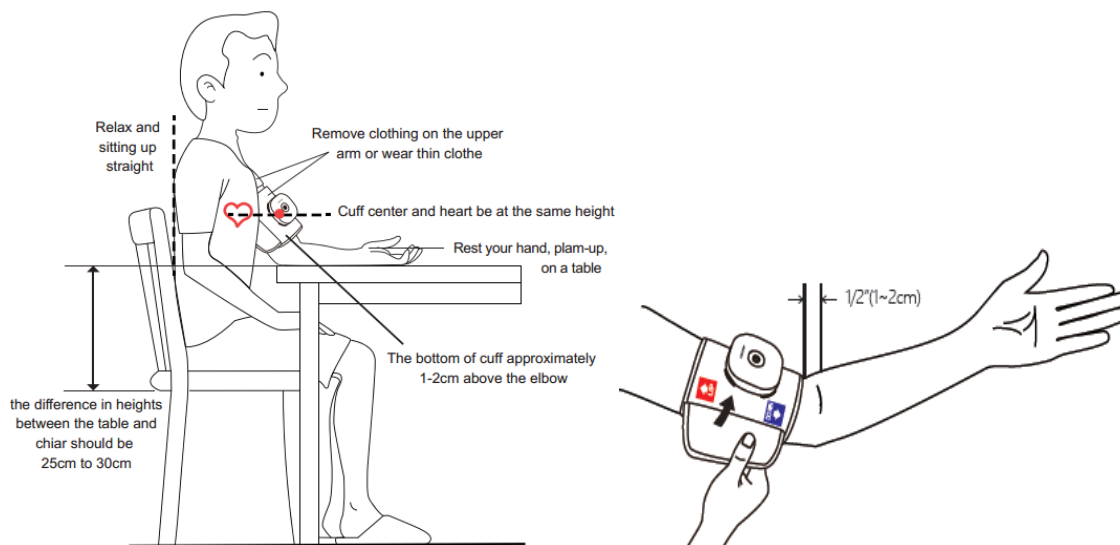

### NOTES

Blood pressure measurement will be influenced by body posture, wearing method of cuff, physical condition, surrounding environment. The position of cuff and heart shall be kept at a same horizontal level during measurement.

1. Keep calm for 5 minutes before measurement. Do not speak or talk during measurement to avoid influence on accuracy. Arm shall be kept naked or dressed in thin cloth.
2. Power on the device and buckle in the cuff correctly. Tie up the cuff 1-2 cm upper elbow joint. Degree tightness should be comfortable.
3. Sit up straight. Keep limb positioned on a stable table or platform with proper height. Keep the palm up and relaxed. The position of cuff and heart shall be kept at a same horizontal level during measurement.
4. Open HC-03U. Select blood pressure and click "Start". The cuff will be inflated, and measurement will be started. Keep calm during measurement.
5. HC-03U will stop automatically after measurement. The measured value will be shown.
6. Take off the cuff and clear up. Do not evaluate the result only by your own experience. Please consult the doctor.

### Blood Pressure Differences When Lying Down, Standing Up, And Sitting

Accurate blood pressure measurements may be obtained in a number of ways. There are three common

positions that a healthcare provider may use when taking someone's blood pressure. Taking blood pressure lying down is the obvious method used when a patient is hospitalized, but in a health provider's office, a patient is usually sitting in a chair. Some healthcare providers also measure blood pressure while a person is standing. The position of the patient and other factors can impact blood pressure results.

### **Records Show That Diastolic Pressure Is About 55Mm/Hg Lower When Taking Blood Pressure Lying Down Vs Sitting.**

- Systolic pressure is approximately 88mm/Hg in the lying down position versus the sitting position, but **ONLY** when the person taking the measurement positions the patient's arm so that it is at the same level as the right atrium of the heart.
- All sorts of conditions can have an impact on your blood pressure reading. Disease, stress, weight, and even posture can impact your blood pressure level. Blood pressure lying down versus standing has the same variations as lying down vs. sitting. Moving from a standing to a supine (lying down) position could result in different readings.
- A number of factors influence blood pressure readings based on the position of the patient. Let's take lying down vs. sitting as an example. Our heart is a pump, and it takes less work to pump blood to our brain when we are lying down. This is because our head is about the same level as our hearts. However, when we are up, our head is a lot higher than our heart.
- This means the heart has to pump much harder to get blood to our brain, so as a result, blood pressure is higher.
- In most cases, blood pressure is taken while a person is sitting down with the arm dropping onto a table. While sometimes the middle point of the upper arm might, in fact, be parallel and in line with the position of the heart, the rest of the arm is **NOT**, so it should **NOT** be surprising that a measurement taken while laying down might be a little lower, since there is less gravity to counteract.

### **Blood Pressure Differences Between Arms**

A small difference in blood pressure between arms is nothing to be concerned. However, a large difference, of between 10-to-15 points, could signal health problems that include plaque buildup, kidney disease, diabetes, and heart defects and an increased risk of dying from heart disease or a stroke. Therefore, these differences should be discussed with your healthcare provider.

### **The Correct Posture in Blood Pressure Measuring**

Patient position in normal use, including:

- Comfortable position,
- Legs uncrossed,
- Feet flat on the floor,
- Back straight and arm supported when sitting, and
- Middle of the arm cuff at the level of the right atrium of the heart.



### **WARNINGS**

- Take measurement while still and relaxed.
- **DO NOT** move your body or arms. Relax your body, arm, and fingers and **DO NOT** move.
- **DO NOT** speak or talk.

### **CAUTION**



- Take measurements using the upper arm in the same position at the same time every day. Measurement values will vary according to the height of the pressure arm cuff.
- When sitting or standing keep back straight feet flat on the floor. When reclining keep your back flat and make sure that your legs are **NOT** crossed.
- Blood pressure readings are different if you are in a sitting position with your legs crossed. It increases systolic pressure by as much as **8 Mm/Hg**.

- Remain calm for approximately 4-to-5 minutes before taking measurements.
- Relax and stay in a natural posture when taking measurements.
- ⚠️ • Keep quiet during measurement to avoid impacting the accuracy of the measurement.
- Keep the device in a stable position to ensure that it DOES NOT shake during the test.
- DO NOT inflate the arm cuff when it is NOT wrapped around your arm.
- During measurement:  
DO NOT touch the device or the cuff.  
DO NOT forcibly crease the arm cuff excessively.

#### 04.6 Taking A Reading

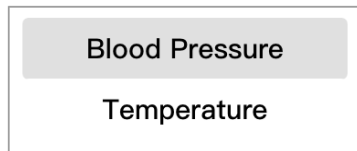

1. Press OK button to enter Blood Pressure measuring menu.

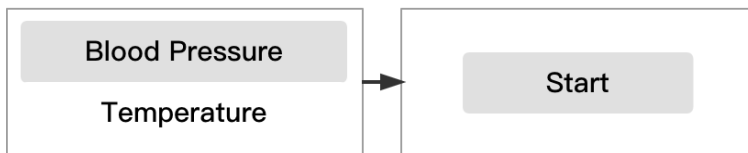

2. Press OK button to start measure Blood Pressure.

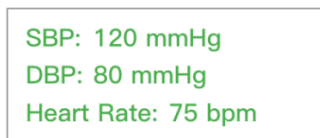
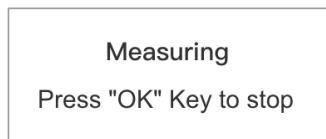

Deflate

3. Complete.  
Beep occurs when measurement starts and finished.

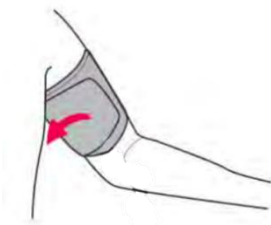

4. Remove the arm cuff.



## WARNINGS

If your systolic pressure is more than 210mmHg after the arm cuff starts to inflate, press and hold the "STOP" button until the device inflates 30 to 40mmHg higher than your expected systolic pressure. Always consult your healthcare provider. Self-diagnosis of measurement results and self-treatment are dangerous.

## **CAUTION**



- To cancel a measurement, tap the " STOP " button to turn the measuring off and to release the air in the arm cuff.
- Keep the device in a secure position to ensure it DOES NOT shake during the test.
- DO NOT move your body or arms.
- DO NOT speak during testing.
- Remain calm and still during testing to avoid impacting the accuracy of the measurement.
- DO NOT measure the same arm continuously. If multiple measurements are needed, the interval between the two measurements should be at least 30 Seconds.
- Wait Several Minute s after urinating before taking measurements.



## NOTES

- Remain still while taking measurement.
- It is better to measure your basic blood pressure (the blood pressure when you get up in the morning without pee feeling). If NOT available, please measure your blood pressure before eating and before intense physical exercise.
- It is better to ensure 2-3 minutes of intermission between consecutive measurements.

### 04.7 Read the Blood Pressure Display

The blood pressure value and pulse are displayed at the same time. Blood pressure values are displayed alternately in mmHg units.

SBP: 120 mmHg  
DBP: 80 mmHg  
Heart Rate: 75 bpm

## 04.8 Illustrated Example of Measuring Blood Pressure

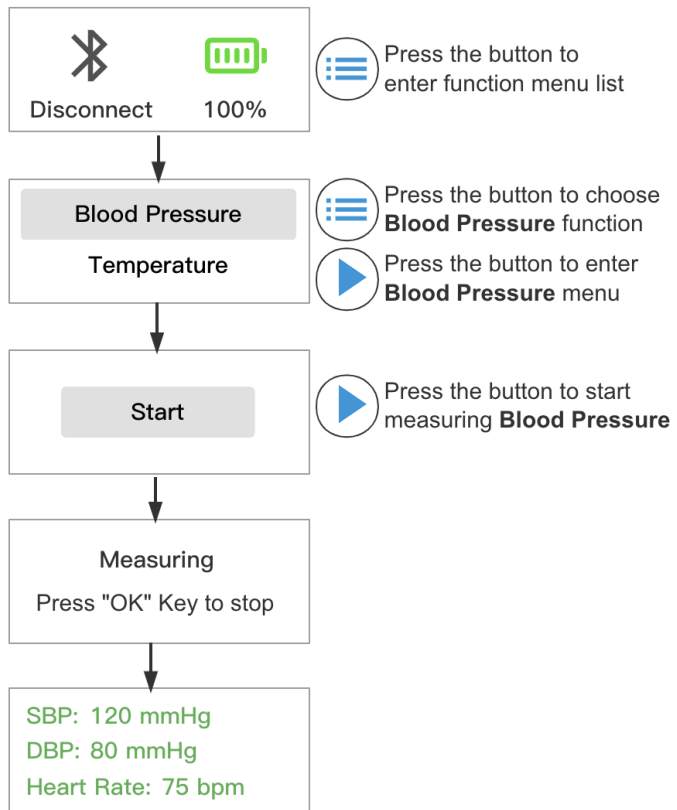

## 04.9 Troubleshooting

Malfunctions	Reason	Solution
Low reading	Wrong wrapping of cuff Moving, speaking, or wrong sitting posture during measurement	Wrap the cuff correctly Adjust the sitting posture, keep calm during measurement Please refer to user manual for operation details.
Failure of inflating	Air leakage of cuff or wrong position of device	Re-position the device. Contact the manufacturer for replacing the cuff if cuff is broken.
Failure of measurement	Wrong position of device, or inadequate power	Check the position of device by referring to user manual. Check the power quantity. Charge timely due to low power. Please refer to user manual for operation details.

## 05 MEASURING FOREHEAD TEMPERATURE

### 05.1 Overview

The innovative infrared technology allows the measurement after being placed on the forehead within seconds. The device can take a measurement automatically when the device is placed on the forehead.

#### Measurement Range:

34°C~42°C (93.2°F~107.6°F)

#### Color coded and audible Information (Forehead Temperature Results)

The device is designed to give you an easy indication reading with color measuring results which illuminate after taking the reading:

	RESULTS COLOR	MEANING
97.2 ~ 99.0°F (36.2 ~ 37.2°C)	Green	Acceptable
Other readings	Red	Consult a healthcare provider

### 05.2 Safety Information



#### WARNINGS

- DO NOT measure with the environment temperatures below 41 °F (+5 °C), or above 104 °F (+40 °C).
- DO NOT measure with humidity below 10% or above 85%.
- **EXPLOSION HAZARD.** DO NOT use the device in the presence of flammable anesthetics mixed with air, oxygen, or hydrogen (such as in a hyperbaric chamber, ultraviolet sterilizer or oxygen tent).
- The device and forehead temperature function are NOT designed for people less than 5 years of age.
- NOT for use on critically ill patients, patients in shock, dehydrated patients, or hyperosmolar patients.

- DO NOT use the device for any purpose other than measuring forehead temperature or other functions of the device.
- This device is NOT intended for treatment.
- If you are taking medication, consult your healthcare provider to determine the most appropriate time to measure your forehead temperature. NEVER change prescribed medication without consulting your healthcare provider.
- Always consult your healthcare provider regarding measurements obtained by the device or before beginning or modifying any exercise program.



### CAUTION

- DO NOT use the device in the bathroom or wet environments.
- To ensure accurate readings, keep the device at room temperature for more than 30 Minutes before use.
- Many people may NOT have an elevated temperature even if they are ill. In the following cases, please consult your healthcare provider before using the device:
  - . People on steroids, antibiotics or antipyretics.
  - . People with compromised immune systems.
- Measurement should NOT be taken unless completely relaxed and still.
- Avoid any drafts (e. g. from air conditioning, etc.)
- Allow a 1-minute interval between each measurement.
- Apply device to forehead to obtain measurement.
- The protective glass over the lens is the most fragile part of the device thermometer.
- DO NOT touch the tip of the temperature probe which houses a precise temperature sensor.
- Keep the temperature probe clean to ensure accurate readings.
- Clean the thermometer after each use. Please refer to Chapter 8 "Cleaning & Disinfection" for details.



### NOTES

Normal body temperature varies from person to person. Tracking an individual's temperature consistently will help determine whether a fever is present. Similar to other thermometers, measurement error may occur within a range of  $\pm 0.5^{\circ}\text{F}$  ( $\pm 0.3^{\circ}\text{C}$ ).

### 05.3 Display & Symbols Bank

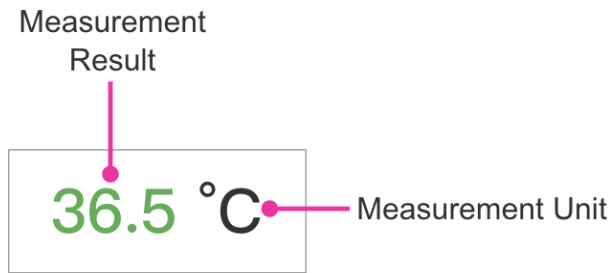

### 05.4 Taking A Reading

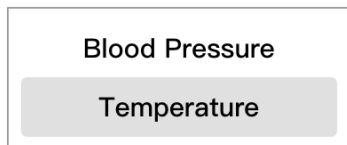

1. Press OK button to enter Temperature measuring menu.

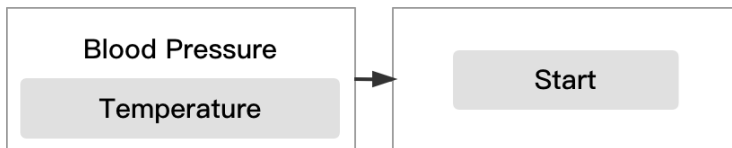

2. Place the temperature sensor on the forehead.

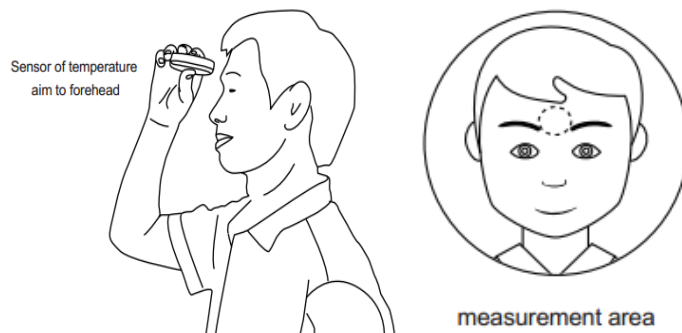

3. Press OK button to start measure forehead temperature. The measurement starts in 5 seconds. Hold the device, placing the temperature sensor on the forehead.



4. Beep will occur when measurement starts and finishes.



## CAUTION

- The device is **ONLY** suitable for use in indoor climate-controlled environments.
- Always remain calm and sit quietly for approximately 4-to-5 minutes before taking measurements.
- Clean the temperature probe and forehead before and after each measurement.
- **DO NOT** pour or spray liquids onto the temperature probe, and **DO NOT** allow any liquid to enter any openings in the device.
- **DO NOT** hold the device for extended periods as this could warm the device and result in an inaccurate reading.
- The device is only intended for temperature measurement on the forehead and should **NOT** be used for temperature measurement anywhere other than the forehead.
- Keep still and **DO NOT** move or speak until the reading is complete.
- Wait at least An Hour and keep a quiet for while after hard exercise or a hot bath to take body temperature. **DO NOT** take measurements if your skin is wet.
- Wait at least at least 20 Minutes to take measurements after coming in from cold places.
- Wait at least 20 Minutes after light exercise, or if you smoke or, drink a hot or cold liquid.
- Make sure the skin on your forehead is dry and clean before taking each measurement.
- Take the device and align the infrared detection head to the center of forehead.
- Keep the device 1-2cm away from skin.



## NOTES

- Holding the thermometer too long may cause a higher ambient temperature reading of the probe. This could make the body temperature measurement lower than usual.
- It may affect the accuracy of measurements when the forehead is covered by hair, perspiration, cap or scarf.
- When the temperature is between 97.2°F / 36.2°C to 99.0°F / 37.2°C, there will be a green measurement reading. This indicates that the temperature is normal.
- If there is a red measurement reading, it indicates that you may have a fever. Please consult your healthcare provider regarding this result.

## 05.5 Illustrated Example of Measuring Forehead Temperature

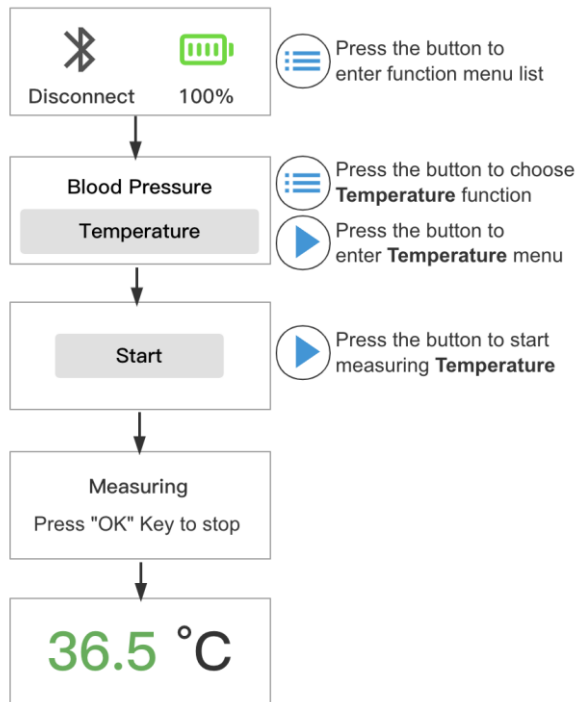

## 05.6 Troubleshooting

Malfunctions	Reason	Solution
Big measurement error	sweat, water, oil and etc. on forehead	Clean the forehead before measurement.
	Wrong measurement distance	Keep 1-2cm distance between detector head and forehead.

## 06 AFTER MEASURING

### 06.1 Measurement Processing

After the measurement is completed, the measurement results will be automatically stored in the measurement record

### 06.2 View the Measuring Result

This HC-03U device's "Record" function can review all the measurements saved in the device.

#### Features include the following results:

- In the home page, short press the function button to enter the function menu, select the Record menu, and short press the OK button to enter the measurement record query page.
- The device stores up to 20 measurement records, and more than 20 measurement records will be covered by new records.
- The measurements are arranged in order from new to old
- Record menu to store blood pressure and temperature measurement records

### 06.3 Check the History

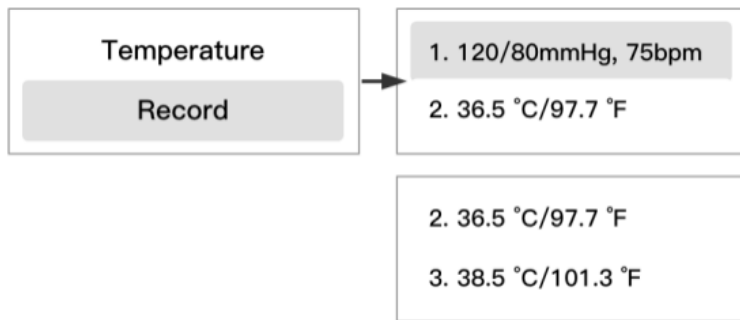

1. TAP & SELECT the Function button.
2. Select the record menu.
3. TAP & SELECT the Function button to read the record up and down.

### 06.4 Delete the History

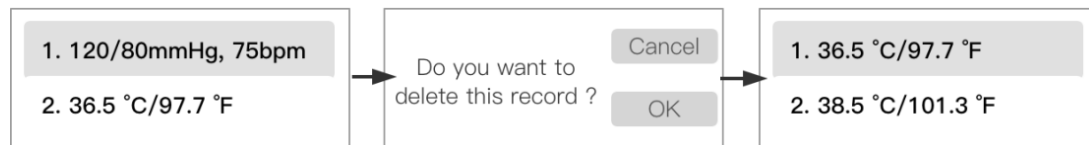

1. In the measurement record page, the cursor selects a measurement record.
2. Press the function button for 3 seconds to pop up at the page.
3. Press the function key briefly to undelete the record.
4. Press the confirmation button to delete the record.
5. After deleting the record, automatically jump to the measurement record list page.

## 07 CLEANING & DISINFECTING

### 07.1 The Difference Between Cleaning & Disinfecting

Cleaning and disinfecting the device is a two-step process.

The first step is the Cleaning.

- Cleaning removes any liquids, dust or dirt from the device.
- Cleaning must be done before Disinfecting.

The second step is Disinfecting.

- Disinfecting removes most, but NOT all possible infectious agents (bacteria or viruses) from the device, including blood borne pathogens.

#### CAUTION

- Please use cotton tissue moistened with water or alcohol (70% Isopropyl) to clean the casing, cuff and the measuring sensor. Take care not to scratch the surface of the sensor lens.
- Ensure that no liquid enters the interior of the device.
- Never use abrasive cleaning agents, thinners or benzene for cleaning and never immerse the device in water or other cleaning liquids.



- Dry with a soft cloth or allow to air dry. Ensure that all surfaces are completely dry.

## 07.2 Safety Information

### WARNINGS



- Failure to follow these instructions will damage the device and prevent it from working properly.
- DO NOT use hot steam or ultraviolet radiation for disinfection. Otherwise, the device may be damaged or age prematurely.
- DO NOT disinfect the device using high-temperature and/or high-pressure disinfecting gas.
- NEVER use autoclaving, ETO or formaldehyde for disinfection.
- DO NOT immerse or soak any part of the device in any liquid.
- Be sure to fully shut down the device and disconnect all power cables from the outlets before cleaning the device.
- DO NOT spray anything onto the device.
- DO NOT pour the liquid onto the device.
- DO NOT allow any liquid to seep into the device during cleaning.
- DO NOT get any moisture in slots or openings.

### CAUTION



- DO NOT clean or disinfect the device while using.
- DO NOT clean the device with any strong dissolving agent such as acetone or other volatile solutions.
- DO NOT clean the device with corrosive cleaners.
- NEVER use abrasive materials (such as steel wool or silver polish) to clean the device.
  
- Using cleaning and disinfecting products could result in damage to the device. If you notice any of the following signs of deterioration after cleaning and disinfecting your device, stop using your device and contact LINKTOP representative or call 0086-592-3691601.
  - . Cloudy device display.
  - . The device displays broken characters or icons.
  - . The device will NOT power on.
  - . Markings on device, including labels that are faded, coming off, or missing.
  - . Device buttons DO NOT function or are hard to operate.
  - . If an automatic self-test gives an error message.



### NOTES

- Inaccurate measurements may be caused by autoclaving, ethylene oxide sterilizing, or immersing the sensors in liquid may cause inaccurate readings.
- Make sure NO liquids enter the test port or any other opening in the device.

## 07.3 How to Clean and Disinfect the Device

Please use cotton tissue moistened with water or alcohol (70% Isopropyl) to clean the casing, cuff and the measuring sensor. Take care not to scratch the surface of the sensor lens.

Ensure that no liquid enters the interior of the device.

Never use abrasive cleaning agents, thinners or benzene for cleaning and never immerse the device in water or other cleaning liquids.

Dry with a soft cloth or allow to air dry. Ensure that all surfaces are completely dry.

 **CAUTION**

- When wiping the side panel of the device, be especially careful to keep liquid away from the cable and the outlet.
- The following parts of the device should be cleaned and disinfected:
  1. The area around slots and openings. (DO NOT get any moisture in slots or openings). The device display screen.
  2. The entire device's surface.



- Make sure NO liquids enter the test port or any other opening in the device.
- DO NOT spray device with any cleaning agents.
- DO NOT wrap or scrub the device with the wipe to keep the surfaces wet.



**NOTES**

- Allow the device to air dry thoroughly before use.
- If the cable or plug accidentally gets wet, rinse them with distilled or deionized water and dry them completely prior to use.



**CAUTION**

- Make sure NO liquids enter the test port or any other opening in the device.
- DO NOT spray device with any cleaning agents.
- DO NOT wrap or scrub the device with the wipe to keep the surfaces wet.

#### **07.4 How to Clean & Disinfect the Arm Cuff**

- Use a soft and dry cloth, or a soft and moistened cloth and neutral soap to clean on the arm cuff.
- To clean/disinfect, utilize a surface disinfectant/decontaminant cleaner and follow the directions on the disinfectant/decontaminant label. Allow the cuff to air dry thoroughly after cleaning and rinsing.
- Examine for physical integrity after cleaning or disinfection.



**CAUTION**

- It is recommended that the Arm Cuff be thoroughly cleaned between uses.
- Care should be taken to keep liquid from entering the Tubes and Inflation Bulb/Valve.
- DO NOT press cuff with a hot iron.
- DO NOT use steam or heat to sterilize the cuff or tubing.
- DO NOT use petrol, thinners or similar solvents to clean the arm cuff.
- DO NOT wash the arm cuff or immerse it in water.
- DO NOT allow foreign debris to ingress into the cuff tubes.



**NOTES**

Liquid inside the tubes may damage the device or affect the accuracy of the blood pressure reading.

## 08 STORAGE & MAINTENANCE

### 08.1 Storage

- Keep out of reach of children, animals, persons with disabilities and the infirm. This kit contains small parts which could pose as entanglement or choking hazard to small children.
- Adult supervision is required.

**To keep the device in the best condition and protect the device from damage, follow the directions listed below:**

- Store the device and components in a clean, safe location.
- Always store or transport the device in its original carrying case when NOT in use.
- Make sure the AC Adapter is placed under the main unit so that it DOES NOT damage the display.
- Avoid kinking or sharply bending the AC Adapter cord.
- Supervise children around the device to ensure they DO NOT play with it.
- DO NOT stack with other equipment as this could result in damage or improper operation.
- Check whether safety risks exist regularly and DO NOT use the device if damaged.

**Keep the arm cuff in its original carrying case when NOT in use.**

### 08.2 Safety Information



#### WARNINGS

Keep the device away from corrosive substances, explosive substances, high/low temperature, and moisture.



#### CAUTION

- DO NOT subject the device or exposed to extreme temperatures, marked temperature fluctuations, humidity, moisture, direct sunlight, corrosive vapors, dirt, dust and any other type of contaminating substance.
- DO NOT strike the device or use around sharp materials.
- Avoid moving the device from a cold to a hot and humid environment.
- DO NOT expose the device to water or wet environments.
- DO NOT submerge the device or any of the components in water or any other liquid.
- DO NOT subject the device to water and liquid spillage.
- DO NOT spray any liquid on the device directly.
- DO NOT wash this device with water.
- DO NOT use with any lotions.
- DO NOT use excessive force on the sensor.
- DO NOT disassemble the device.
- DO NOT place objects on top of the device. This could damage the device.
- DO NOT drop the device or subject it to strong shocks, vibrations.
- DO NOT sterilize this device in an autoclave or gas sterilizer (EOG, formaldehyde, high- density ozone, etc.) Autoclaving, ethylene oxide sterilizing, or immersing, the sensors in liquid may cause inaccurate readings.
- DO NOT store the device in the following ambient conditions:
  - . Locations exposed to direct sunlight.
  - . Locations with extremes in temperature and humidity.
  - . Locations subject to high temperatures and high humidity.
  - . Wet or damp locations.

- . Dusty locations.
- . Near a source of fire or heat.
- . Locations exposed to strong vibration.
- . Locations exposed to strong electromagnetic fields.
- DO NOT fold the arm cuff tightly.

### NOTES

- The housing of the device is NOT UV resistant.
- Keep the device away from water or other liquid.
- Water-resistance is NOT a permanent condition, and the device CANNOT be rechecked or resealed for water resistance.
- Refer to Chapter 08 " Cleaning & Disinfection ".

## 08.3 Maintenance

### Before first use, follow these guidelines when inspecting the equipment:

- Make sure that the environment and power supply meet the specifications.
  - Inspect the equipment and its accessories for mechanical damage.
  - Inspect all power cords for damage, and make sure that their insulation is in good condition.
  - Make sure that only specified accessories are applied.
  - Make sure that HC-03U device is in good working condition.
- The accuracy of the device has been carefully tested and is designed for long service life.
  - This device DOES NOT require calibration during the expected life cycle.
  - DO NOT disassemble the device. There are NO user-serviceable parts.
  - Recommend periodic (about once every 3 months) recharge to the device to keep the battery voltage in working order.

### WARNINGS

- Use ONLY LINKTOP authorized parts and accessories. Parts and accessories NOT approved for use with the device may damage the device.

### CAUTION

- DO NOT attempt to service the device yourself, if a defect occurs, please contact LINKTOP Representative or call 0086-592-3691601 immediately.
- Changes or modifications NOT approved by the manufacturer will void the user warranty and could result in improper operation of the device.

## 08.4 Discarding

- LINKTOP is committed to recycling and sustainability.
- Comply with any laws or ordinances relating to the disposal of contaminated products. Contact your local health department or other appropriate authorities for proper handling and disposal of medical waste, electronic devices, and used batteries. Consider the following points when discarding used testing materials:
  - . Please follow the law of the local government to deal with the used device and the accessories.
  - . DO NOT dispose of the device in the household waste at the end of its useful life.

- . Be aware the device is potentially hazardous electronic scrap (e-scrap) and should be disposed of accordingly.
- . Disinfect the device before recycling or discarding.

 **CAUTION**

- Please follow the law of the local government regarding used batteries.
- DO NOT dispose of in fire, as the device contains a lithium battery that may explode.
- DO NOT dispose of this device as " UNSORTED MUNICIPAL WASTE ". The disposal of scrap device and its accessories and packing (including battery, plastic bags, foams, and paper boxes) should follow the local laws and regulations. For environmental reasons, unlawful disposal may cause environmental pollution. If you have any questions concerning the disposal of the device, we recommend please contact LINKTOP representative or call 0086-592-3691601.

 **NOTES**

LINKTOP cares for the environment and encourages its customers to recycle HC-03U devices and genuine HC-03U accessories. Proper disposal of your device and its battery is NOT ONLY important for safety, but it also benefits the environment. Batteries must be recycled or disposed of properly. Dispose of unwanted electronics through an approved recycler. For customer service, please visit our web site at [www.linktop.com](http://www.linktop.com) or contact LINKTOP representative or call 0086-592-3691601.

## 09 SPECIFICATIONS

<b>Product name</b>	Health Monitor	<b>Product Model</b>	HC-03U
<b>Battery Nominal Voltage</b>	3.7V	<b>Input Voltage</b>	5V±0.25V
<b>Battery Rated Capacity</b>	400mAh	<b>Size</b>	70mm×70mm×18.4mm
<b>Working frequency</b>	2.4000-2.4835GHz	<b>Net Weight</b>	about 70g
<b>Communication Protocol</b>	Bluetooth 5.1	<b>Resting pressure rated range</b>	0-300mmHg
<b>Validity period of product</b>	3 years	<b>Validity period of cuff</b>	2 years
<b>Lifetime of battery</b>	charge-discharge cycles 300 times		

<b>Blood pressure measurement</b>	
<b>Measurement body part</b>	Upper arm
<b>Applied arm circumference of cuff</b>	22-35cm
<b>Measurement scope of systolic pressure</b>	60-230mmHg
<b>Measurement scope of diastolic pressure</b>	40-130mmHg
<b>Pressure error</b>	±3mmHg
<b>Measurement scope of pulse rate</b>	40- 180bPm
<b>Pulse rate error</b>	±5%

<b>Body temperature measurement</b>	
<b>Technique</b>	infrared temperature
<b>Measurement body part</b>	Forehead
<b>Measurement range</b>	34°C~42°C (93.2°F~107.6°F)

<b>Measuring error</b>	$\pm 0.3^{\circ}\text{C}$
------------------------	---------------------------

<b>Working condition</b>	
<b>Temperature</b>	$5^{\circ}\text{C}\sim 40^{\circ}\text{C}$
<b>Humidity</b>	$10\%\sim 85\%$
<b>Atmospheric Pressure</b>	$70\sim 106\text{ kPa}$

<b>Storage/Transport condition</b>	
<b>Temperature</b>	$-20^{\circ}\text{C}\sim +60^{\circ}\text{C}$
<b>Humidity</b>	$\leq 93\%$
<b>Atmospheric Pressure</b>	$50\sim 106\text{ kPa}$

## 10 LIMITED WARRANTY

### 10.1 Manufacturer's Warranty

- The device has been calibrated before leaving the factory.
- Please check the packing before use to make sure the device and accessories fully reflect the items included on the packing list.
- LINKTOP warrants to the original purchaser that this device will be free from defects in materials and workmanship for 1 Year from the date of original purchase when used in accordance with this USER MANUAL (except as noted below).
- The limited warranty from the Date of Purchase.
- This warranty is NOT transferable.
- The above warranty extends ONLY to the original retail purchaser.
- This warranty covers parts and labor costs when, upon examination by the manufacturer, the device is determined to be defective.
- During the stated period, LINKTOP shall at NO charge, replace a unit found to be defective with an equivalent or current version of the same model.
- To implement the provisions of warranty repair, the purchaser must notify LINKTOP concerning suspected defects and then, if so instructed, ship the device to the designated facility, correctly packed in an appropriate shipping container, for examination and servicing.
- The product must be packed carefully to prevent damage in transit. Because of possible loss in transit, we recommend ensuring the product with return receipt requested.
- The foregoing is the sole warranty provided by LINKTOP in connection with this product, and LINKTOP Hereby disclaims any other warranties, express or implied, including implied warranties of merchantability and fitness for a particular purpose.

### WARNINGS

- The foregoing is the sole warranty provided by LINKTOP in connection with this product, and LINKTOP Hereby disclaims any other warranties, express or implied, including implied warranties of merchantability and fitness for a particular purpose.
- Implied warranties and other terms that may be imposed by law, if any, are limited in duration to the period of the above express warranty. LINKTOP shall NOT be liable for loss of use or any other special, incidental, consequential or indirect costs, expenses or damages.
- This warranty provides you with specific legal rights, and you may have other rights that vary by jurisdiction. Because of special local requirements, some of the above limitations and exclusions may NOT apply to you. For customer service, please visit our web site at [www.linktop.com](http://www.linktop.com) , contact LINKTOP representative or call 0086-592-3691601.

## 10.2 Limitations of Warranty



### CAUTION

- This warranty is subject to the following exceptions and limitations.
- A 90-day warranty ONLY will be extended for consumable parts and/or accessories.
- Notwithstanding anything to the contrary contained herein, LINKTOP, shall not be liable for any delays or failures in performance resulting from acts beyond its reasonable control including, without limitation, acts of God, terrorist acts, shortage of supply, breakdowns or malfunctions, interruptions or malfunction of computer facilities, or loss of data due to power failures or mechanical difficulties with information storage or retrieval systems, labor difficulties, war, or civil unrest.
- This warranty is limited to replacement due to defects in parts or workmanship. LINKTOP shall NOT be required to replace any units which malfunction or are damaged due to abuse, accidents, alteration, misuse, neglect, maintenance by someone other than LINKTOP, or failure to operate the instrument according to the instructions in this USER MANUAL.
- LINKTOP assumes NO liability for malfunction or damage to LINKTOP device caused by the use of reagents other than reagents manufactured or recommended by LINKTOP
- This warranty DOES NOT cover repairs necessitated by any damage to the device caused by mishandling, neglect, abuse, customer modification or failure of the user to follow the operating instructions contained in this USER MANUAL.
- The limited warranty is valid ONLY on the presentation of the purchase receipt confirming the date of purchase. Opening or altering the device invalidates the limited warranty.
- LINKTOP reserves the right to make design changes in its products without incurring the obligation to incorporate these changes in products previously delivered.
- LINKTOP reserves the right to make changes in the design of this device without obligation to incorporate such changes into previously manufactured devices.
- This warranty applies unless LINKTOP has agreed to and provided a written exception.
- LINKTOP makes NO warranty for any data or information that is collected erroneously by the device, or misuse or malfunction as a result of abuse, accidents, alteration, misuse, neglect, or failure to maintain the products as instructed.
- Interpretations made by this device are potential findings, NOT a complete diagnosis of your physiological data. All interpretations should be reviewed by your healthcare provider or other medical professionals necessary for clinical decision making.

## 10.3 User Responsibility

- This device ONLY be used for the purposes described in this USER MANUAL. DO NOT use the device for any other purpose. Always follow the operating procedures described in this USER MANUAL. The manufacturer CANNOT be held liable for damage or injury caused by incorrect use.
- Please use accessories and detachable parts specified/authorized by LINKTOP. Otherwise, it may cause damage to the unit or danger to the user/patients.
- The use of accessories, transducers, and cables other than those specified or provided by the manufacturer of this HC-03U device could result in increased electromagnetic emissions or decreased electromagnetic immunity of this equipment and result in improper operation.
- The use of accessories, sensors, and cables other than those specified may result in increased emission, low anti-disturbance and/or may lead to the device producing invalid readings.
- Portable RF communications equipment (including peripherals such as antenna cables and external antennas) should be used no closer than 30 cm (12 inches) to any part of this HC-03U device, including cables specified by the manufacturer. Otherwise, degradation of the performance of this equipment could result.



- All repairs on products under warranty must be performed or approved by LINKTOP, Unauthorized repairs will void the warranty. DO NOT attempt to repair the device yourself.
- Any product repair shall exclusively be performed by LINKTOP certified service personnel. Any changes or modifications to LINKTOP equipment, NOT expressly approved by LINKTOP, will void the warranty and could result in improper operation of the device.
- The user of the device shall have the sole responsibility for any malfunction, which results from improper use, faulty maintenance, damage or alteration.

#### 10.4 What's NOT Covered by Warranty

- A device that is NOT in original condition.
- The shell of the device is broken or cracked.
- Evidence of water damage.
- Accessories or appearance of the device has been abused.
- Evidence of crushing damage to the I.R Probe.
- Original package is NOT used during transportation.
- Evidence of non-authorized service.
- Unauthorized use of the device.
- If the code label or parts are damaged or missing.
- Damage to I.R Probe caused by excessive force.
- Damage to the device due to failure to conform to this USER MANUAL specifications.
- Evidence of smear or marks that CANNOT be removed from the outside surface.
- Evidence that the circuit is shorted and damaged due to liquid or other substances in the device.
- For routine device maintenance, please refer to the service procedures at the associated section as indicated in this USER MANUAL.
- As to the other concerns for attention, please carefully look through the specific chapter in this USER MANUAL and enclosed instructions.
- This USER MANUAL describes all features and options. This model may NOT have all the accessories referenced in this USER MANUAL.
- Some items may NOT be included in the kit and must be purchased separately.
- This warranty gives you specific legal rights, and you may also have other rights which may vary from state to state.



#### CAUTION

**FOR CUSTOMER SERVICE.** Visit our web site at [www.linktop.com](http://www.linktop.com) or please contact LINKTOP representative or call 0086-592-3691601.

#### 10.5 Precautions for Transfer and Disposal

If data stored on this device is deleted or reformatted using standard methods, or the data ONLY appears to be removed on a superficial level, and it may be possible for someone to retrieve and reuse the data by using special software.

To avoid unintended disclosure of information, it is recommended that the device be returned to LINKTOP representative or LINKTOP for an Extended File System (EFS) Clear which will eliminate all user memory and return the device to its default settings. Please visit our web site at [www.linktop.com](http://www.linktop.com) or contact LINKTOP representative or call 0086-592-3691601 for more detail information.

**LINKTOP**



Xiamen Linktop Technology Co., Ltd.

Address: Room 501-2,502,503, North Building, Torch Hi-Tech Zone, No.56-58 Huoju Road, Xiamen, 361000, Fujian, P.R. China.

Website: [www.linktop.com](http://www.linktop.com)

Email: [service@linktop.com](mailto:service@linktop.com)



Share info GmbH

Address: Heerdter Lohweg 83, 40549 Düsseldorf

Email: [eu-rep@share-info.com](mailto:eu-rep@share-info.com)



## WARNINGS

Please provide warranty information (proof of purchase) to LINKTOP Representative or LINKTOP in order for the company to provide this service at no charge.

If the warranty has expired on the device, charges may apply.

## 10.6 End User License Agreement for Software

### IMPORTANT. READ CAREFULLY

This End User License Agreement ("EULA") is a legal agreement between you (either an individual or a single entity) and LINKTOP for software owned by LINKTOP and its affiliate companies and Third-Party suppliers and licensors that accompanies this EULA, which includes computer software and may include associated media, printed materials, "online" or electronic documentation ("Software").



## NOTES

When you first use the device and after the App OS start up, the EULA page will display on the device. By clicking the " I accept " button (or if you bypass or otherwise disable the " I accept ", and still install, copy, download, access or otherwise use the software), you agree to be bound by the terms of this EULA. If you DO NOT accept the terms in this EULA, you must click the " Decline " button, and discontinue use of the software.

### 1. GRANT OF LICENSE

LINKTOP grants you the following rights provided that you comply with all terms and conditions of this EULA. You may install, use, access, display and run one copy of the Software on a local hard drive.

### 2. RESERVATION OF RIGHTS AND OWNERSHIP

LINKTOP reserves all rights NOT expressly granted to you in this EULA. The Software is protected by copyright and other intellectual property laws and treaties. LINKTOP or its suppliers own the title, copyright and other intellectual property rights in the Software. The Software is licensed NOT sold.

### 3. LIMITATIONS ON END USER RIGHTS

You may NOT reverse engineer, decompile, disassemble, or otherwise attempt to discover the source code or algorithms of, the Software (except and ONLY to the extent that such activity is expressly permitted by applicable law NOT withstanding this limitation), or modify, or disable any features of, the Software, or create derivative works based on the Software.

You may NOT rent, lease, lend, sublicense or provide commercial hosting services with the Software.

### 4. UPGRADES

This EULA applies to updates, supplements and add-on components (if any) of the Software that LINKTOP may provide to you or make available to you after the date you obtain your initial copy of the Software, unless we provide other terms along with such upgrade. To use Software identified as an upgrade, you must first be

licensed for the Software identified by LINKTOP as eligible for the upgrade. After upgrading, you may NO longer use the Software that formed the basis for your upgrade eligibility.

#### **5. SOFTWARE TRANSFER**

You may NOT transfer this EULA or the rights to the Software granted herein to any third party unless it is in connection with the sale of the mobile device which the Software accompanied. In such event, the transfer must include all of the Software (including all component parts, the media and printed materials, any upgrades, this EULA) and you may NOT retain any copies of the Software. The transfer may NOT be an indirect transfer, such as a consignment. Prior to the transfer, the end user receiving the Software must agree to all the EULA terms.

#### **6. EXPORT RESTRICTIONS**

You acknowledge that the Software is subject to export restrictions of various countries. You agree to comply with all applicable international and national laws that apply to the Software, including the U.S. Export Administration Regulations, as well as end user, end use, and destination restrictions issued by U.S. and Other Governments.

#### **7. TERMINATION**

This EULA is effective until terminated. Your rights under this License will terminate automatically without notice from LINKTOP if you fail to comply with any of the terms and conditions of this EULA. Upon termination of this EULA, you must cease all use of the Software and destroy all copies, full or partial, of the Software.

#### **8. U.S. GOVERNMENT END USERS RESTRICTED RIGHTS**

The Software is licensed ONLY with " Restricted Rights " and as " Commercial Items " consisting of " Commercial Software " and " Commercial Software Documentation " with ONLY those rights as are granted to all other end users pursuant to the terms and conditions herein. All Software and Products provided to the United States Government pursuant to solicitations issued on or after December 1, 1995. is provided with the commercial rights and restrictions described elsewhere herein. All Software and Products provided to the United States Government pursuant to solicitations issued prior to December 1, 1995. are provided with RESTRICTED RIGHTS as provided for in FAR, 48 CFR 52.227-14 (JUNE 1987) or DFAR, 48 CFR 252.227-7013 (OCT 1988), as applicable.

#### **9. APPLICABLE LAW**

This EULA is governed by the Laws of the United States of America (U.S.A), without regard to conflict of laws principles.

This EULA shall NOT be governed by the UN Convention on Contracts for the International Sale of Goods, the application of which is expressly excluded. If a dispute, controversy or difference is NOT amicably resolved, it shall be resolved by arbitration at a location selected by LINKTOP in the State of Indiana, U.S.A in accordance with the Arbitration Rules of the U.S.A Commercial Arbitration Board. The award of arbitration shall be final and binding upon the parties.

#### **10. ENTIRE AGREEMENT; SEVERABILITY**

This EULA is the entire agreement between you and LINKTOP relating to the Software and supersedes all prior or contemporaneous oral or written communications, proposals and representations with respect to the Software or any other subject matter covered by this EULA. If any provision of this EULA is held to be void, invalid, unenforceable or illegal, the other provisions shall continue in full force and effect.

## 11 IEC60601-1-2 EMC & RF STATEMENT

### WARNINGS

#### IMPORTANT INFORMATION REGARDING ELECTRO MAGNETIC COMPATIBILITY (EMC)

- With the increased number of electronic devices such as PC's and mobile (cellular) telephones, medical devices in use may be susceptible to electromagnetic interference from other devices. Electromagnetic interference may result in incorrect operation of the medical device and create a potentially unsafe situation. Medical devices should also NOT interfere with other devices.
- In order to regulate the requirements for EMC (Electro Magnetic Compatibility) with the aim to prevent unsafe product situations, the IEC 60601-1-2 Standard has been implemented.
- This standard defines the levels of immunity to electromagnetic interferences as well as maximum levels of electromagnetic emissions for medical devices.
- Medical devices manufactured by LINKTOP conform to this IEC 60601-1- 2:2007 Standard for both immunity and emissions.
- Nevertheless, special precautions need to be observed:

The use of accessories and cables other than those specified by LINKTOP, with the exception of cables sold by LINKTOP as replacement parts for internal components, may result in increased emission or decreased immunity of the device.

The medical devices should NOT be used adjacent to or stacked with other equipment.

In case adjacent or stacked use is necessary, the medical device should be observed to verify normal operation in the configuration in which it will be used.

Refer to further guidance below regarding the EMC environment in which the device should be used.

The MEDICAL ELECTRICAL EQUIPMENT HC-03U device requires special precautions regarding EMC and must be installed and put into service according to the EMC information provided in this documentation.

The HC-03U device including AC adapter may be interfered with by other equipment, even if that other equipment complies with CISPR EMISSION requirements.

#### GUIDANCE & MANUFACTURER'S DECLARATION

Refer to the following tables for specific information regarding this device's compliance to IEC 60601-1-2.

##### Manufacturer's declaration – electromagnetic emissions

The Electronic Stethoscope is intended for use in the electromagnetic environments specified below. The customer or the user of the Electronic Stethoscope should assure that it is used in such an environment.		
Emissions test	Compliance	Electromagnetic environment - guidance
RF emissions CISPR 11	Group 1	The Electronic Stethoscope use RF energy only for its internal function. Therefore, its RF emissions are very low and are not likely to cause any interference in nearby electronic equipment.  The Electronic Stethoscope is suitable for use in all establishments, including domestic establishments and those directly connected to the public low-voltage power supply network that supplies buildings used for domestic purposes.
RF emissions CISPR 11	Class B	
Harmonic emissions IEC 61000-3-2	Not applicable	
Voltage function / flicker emissions IEC 61000-3-3	Not applicable	

##### Manufacturer's declaration – electromagnetic immunity

The Electronic Stethoscope is intended for use in the electromagnetic environment specified below. The customer or the user of the Electronic Stethoscope should assure that it is used in such an environment.

Immunity test	IEC 60601 test level	Compliance level	Electromagnetic environment - guidance
Electrostatic discharge (ESD) IEC 61000-4-2	±8kV contact ±2, 4, 8, 15kV air	±8kV contact ±2, 4, 8, 15kV air	Floors should be wood, concrete or ceramic tile. If floors are covered with synthetic material, the relative humidity should be at least 30%.
Electrostatic transient / burst IEC 61000-4-4	±2kV for power supply lines ±1kV for input/output lines	Not applicable (Battery operated device)	Mains power quality should be that of a typical commercial or hospital environment.
Surge IEC 61000-4-5	±1kV differential mode ±2kV common mode	Not applicable (Battery operated device)	Mains power quality should be that of a typical commercial or hospital environment.
Voltage dips, short interruptions and voltage variations on power supply input lines  IEC 61000-4-11	<5% UT (>95% dip in UT) for 0.5 cycle  40% UT (60% dip in UT) for 5 cycles  70% UT (30% dip in UT) for 25 cycles <5% UT (>95% dip in UT) for 5 sec	Not applicable (Battery operated device)	Mains power quality should be that of a typical commercial or hospital environment. If the user of the Electronic Stethoscope requires continued operation during power mains interruptions, it is recommended that the Electronic Stethoscope be powered from an uninterruptible power supply or a battery.
Power frequency (50/60 Hz) magnetic field  IEC 61000-4-8	30 A/m	30 A/m	Power frequency magnetic fields should be at levels characteristic of a typical location in a typical commercial or hospital environment.
NOTE $U_T$ is the a. c. mains voltage prior to application of the test level.			

**Manufacturer's declaration – electromagnetic**

The Electronic Stethoscope is intended for use in the electromagnetic environment specified below. The customer or the user of the Electronic Stethoscope should assure that it is used in such an environment.			
Immunity test	IEC 60601 test level	Compliance level	Electromagnetic environment - guidance

<p>Conducted RF IEC 61000-4-6</p>	<p>3Vrms 150kHz to 80MHz</p>	<p>Not applicable (Battery operated device)</p>	<p>Portable and mobile RF communications equipment should be used no closer to any part of the Electronic Stethoscope, including cables, than the recommended separation distance calculated from the equation application to the frequency of the transmitter.</p> <p>Recommended separation distance</p> $d = 1,2\sqrt{P}$
<p>Radiated RF IEC 61000-4-3</p>	<p>10V/m 80MHz to 2.7GHz</p>	<p>10V/m</p>	<p> <math>d = 1,2\sqrt{P}</math> 80 MHz to 800 MHz  <math>d = 2,3\sqrt{P}</math> 800 MHz to 2,7 GHz </p> <p>Where <math>p</math> is the maximum output power rating of the transmitter in watts(W) according to the transmitter manufacturer and <math>d</math> is the recommended separation distance in meter (m)</p> <p>Field strengths from fixed RF transmitters, as determined by an electromagnetic site survey, <sup>a</sup> should be less than the compliance level in each frequency range. <sup>b</sup></p> <p>Interference may occur in the vicinity of equipment marked with the following symbol:</p> 
<p>NOTE 1 At 80 MHz and 800 MHz, the higher frequency range applies. NOTE 2 These guidelines may not apply in all situations. Electromagnetic is affected by absorption and reflection from structures, objects and people.</p>			
<p><sup>a</sup> Field strength from transmitters, such as base stations for radio (cellular/cordless) telephones and land mobile radios, amateur radio, AM and FM radio broadcast and TV broadcast cannot be predicted theoretically with accuracy. To assess the electromagnetic environment due to fixed RF transmitters, an electromagnetic site survey should be considered. If the measured field strength in the location in which the Electronic Stethoscope is used exceeds the applicable RF compliance level above. The Electronic Stethoscope should be observed to verify normal operation. If abnormal performance is observed, additional measures may be necessary, such as reorienting or relocating the Electronic Stethoscope. <sup>b</sup> Over the frequency range 150kHz to 80 MHz, field strengths should be less than 3V/m.</p>			

**Recommended separation distances between portable and mobile**

Test Frequency (MHz)	Band (MHz)	Service	Modulation	Maximum Power (W)	Distance (m)	Immunity Test Level (V/m)
385	380-390	TETRA 400	Pulse modulation 18 Hz	1.8	0.3	27
450	430-470	GMRS 460, FRS 460	FM $\pm 5$ KHz deviation 1KHz sine	2	0.3	28
710	704-787	LTE 13, 17 Band	Pulse modulation 217 Hz	0.2	0.3	9
745						
780						
810	800-960	GSM 800/900, TETRA 800, iDEN 820, CDMA 850, LTE 5 Band	Pulse modulation 18 Hz	2	0.3	28
870						
930						
1720 1845	1700-1990	GSM 1800, CDMA 1900, GSM 1900, DECT, LTE 1, 3, 4, 25 Band, UMTS	Pulse modulation 217 Hz	2	0.3	28

1970						
2450	2400-2570	Bluetooth, WLAN 802.11 b/g/n, RFID 2450, LTE 7 Band	Pulse modulation 217 Hz	2	0.3	28
5240	5100-5800	WLAN 802.11 a/n	Pulse modulation 217 Hz	0.2	0.3	9
5500						
5785						

**Essential Performance**

- The Essential Performance of the NIBP is reproducibility of the blood pressure determination.
- The Essential Performance of the TEMP is providing an output temperature.

These Essential Performances may be affected as a result of exposure to electromagnetic disturbances that are outside of the environments listed in the Indications for Use. If issues are experienced, move This HC-03U device away from the source of electromagnetic disturbances.

**12. FCC Caution**



**Part 15.21**

Any Changes or modifications not expressly approved by the party responsible for compliance could void the user's authority to operate the equipment.

**Part 15.19**

This device complies with part 15 of the FCC Rules. Operation is subject to the following two conditions: (1) This device may not cause harmful interference, and (2) this device must accept any interference received, including interference that may cause undesired operation.

**FCC RF Radiation Exposure Statement:**

1. This Transmitter must not be co-located or operating in conjunction with any other antenna or transmitter.



2. This equipment complies with RF radiation exposure limits set forth for an uncontrolled environment.

3. The device has been evaluated to meet general RF exposure requirement. The device can be used in portable exposure condition without restriction.

#### **Part 15.105**

#### **NOTES**

This equipment has been tested and found to comply with the limits for a Class B digital device, pursuant to part 15 of the FCC Rules. These limits are designed to provide reasonable protection against harmful interference in a residential installation. This equipment generates, uses and can radiate radio frequency energy and, if not installed and used in accordance with the instructions, may cause harmful interference to radio communications. However, there is no guarantee that interference will not occur in a particular installation. If this equipment does cause harmful interference to radio or television reception, which can be determined by turning the equipment off and on, the user is encouraged to try to correct the interference by one or more of the following measures:

- Reorient or relocate the receiving antenna.
- Increase the separation between the equipment and receiver.
- Connect the equipment into an outlet on a circuit different from that to which the receiver is connected.
- Consult the dealer or an experienced radio/TV technician for help.