

FCC SAR EVALUATION REPORT

**In accordance with the requirements of
FCC 47 CFR Part 2(2.1093) and
IEEE Std 1528-2013**

Product Name : Notebook

Trademark : HENA, Azeyou

Model Name : AL152

Family Model : CG15Q03P

Report No. : S24062402811001

FCC ID : 2A27O-AL152

Prepared for

Hena Digital Technology (Shenzhen) Co., Ltd.
13F,Block B,Tairan Building Tairan 8th Road,Futian District,
Shenzhen,China

Prepared by

Shenzhen NTEK Testing Technology Co., Ltd.
1/F, Building E, Fenda Science Park, Sanwei Community,
Xixiang Street Bao'an District, Shenzhen 518126 P.R. China
Tel. 400-800-6106, 0755-2320 0050, 0755-2320 0090
Website: <http://www.ntek.org.cn>

TEST RESULT CERTIFICATION

Applicant's name Hena Digital Technology (Shenzhen) Co., Ltd.
Address 13F,Block B,Tairan Building Tairan 8th Road,Futian District,Shenzhen, China

Manufacturer's Name Hena Digital Technology (Shenzhen) Co., Ltd.
Address 13F,Block B,Tairan Building Tairan 8th Road,Futian District,Shenzhen, China

Product description

Product name..... Notebook
Trademark HENA, Azeyou
Model Name AL152
Family Model..... CG15Q03P
 FCC 47 CFR Part 2(2.1093)

Standards..... IEEE Std 1528-2013
 Published RF exposure KDB procedures

This device described above has been tested by Shenzhen NTEK. In accordance with the measurement methods and procedures specified in IEEE Std 1528-2013 and KDB 865664 D01. Testing has shown that this device is capable of compliance with localized specific absorption rate (SAR) specified in FCC 47 CFR Part 2(2.1093). The test results in this report apply only to the tested sample of the stated device/equipment. Other similar device/equipment will not necessarily produce the same results due to production tolerance and measurement uncertainties.

This report shall not be reproduced except in full, without the written approval of Shenzhen NTEK, this document may be altered or revised by Shenzhen NTEK, personal only, and shall be noted in the revision of the document.

Test Sample Number S240624028011

Date of Test

Date (s) of performance of tests ... Jun. 25, 2024 ~ Jul. 05, 2024

Date of Issue..... Jul. 12, 2024

Test Result **Pass**

Prepared By : Jack Li
 Jack Li
 (Project Engineer)

Reviewed By : Aaron Cheng
 Aaron Cheng
 (Supervisor)

Approved By : Alex Li
 Alex Li
 (Manager)

※ ※ Revision History ※ ※

REV.	DESCRIPTION	ISSUED DATE	REMARK
Rev.1.0	Initial Test Report Release	Jul. 12, 2024	Jack Li

TABLE OF CONTENTS

1. General Information	6
1.1. RF exposure limits.....	6
1.2. Statement of Compliance	7
1.3. EUT Description	7
1.4. Test specification(s)	9
1.5. Ambient Condition.....	9
2. SAR Measurement System	10
2.1. SATIMO SAR Measurement Set-up Diagram	10
2.2. Robot	11
2.3. E-Field Probe.....	12
2.3.1. E-Field Probe Calibration	12
2.4. SAM phantoms	13
2.4.1. Technical Data	14
2.5. Device Holder	15
2.6. Test Equipment List	16
3. SAR Measurement Procedures	18
3.1. Power Reference	18
3.2. Area scan & Zoom scan.....	18
3.3. Description of interpolation/extrapolation scheme	20
3.4. Volumetric Scan	20
3.5. Power Drift	20
4. System Verification Procedure	21
4.1. Tissue Verification	21
4.1.1. Tissue Dielectric Parameter Check Results	22
4.2. System Verification Procedure	23
4.2.1. System Verification Results.....	24
5. SAR Measurement variability and uncertainty	25
5.1. SAR measurement variability.....	25
5.2. SAR measurement uncertainty	25
6. RF Exposure Positions.....	26
6.1. Laptop host platform test requirements	26
7. RF Output Power	27
7.1. WLAN & Bluetooth Output Power	27
7.1.1. Output Power Results Of WLAN	27
8. Stand-alone SAR test exclusion.....	30
9. SAR Results	30
9.1. SAR measurement results	30
9.1.1. SAR measurement Result of WLAN 2.4G	30
9.1.2. SAR measurement Result of WLAN 5.2G	31

9.1.3.	SAR measurement Result of WLAN 5.3G	31
9.1.4.	SAR measurement Result of WLAN 5.6G	32
9.1.5.	SAR measurement Result of WLAN 5.8G	32
9.2.	Simultaneous Transmission Analysis.....	33
10.	Appendix A. Photo documentation	33
11.	Appendix B. System Check Plots	33
12.	Appendix C. Plots of High SAR Measurement.....	44
13.	Appendix D. Calibration Certificate	65

1. General Information

1.1. RF exposure limits

(A).Limits for Occupational/Controlled Exposure (W/kg)

Whole-Body	Partial-Body	Hands, Wrists, Feet and Ankles
0.4	8.0	20.0

(B).Limits for General Population/Uncontrolled Exposure (W/kg)

Whole-Body	Partial-Body	Hands, Wrists, Feet and Ankles
0.08	1.6	4.0

NOTE: **Whole-Body SAR** is averaged over the entire body, **partial-body SAR** is averaged over any 1 gram of tissue defined as a tissue volume in the shape of a cube. **SAR for hands, wrists, feet and ankles** is averaged over any 10 grams of tissue defined as a tissue volume in the shape of a cube.

Occupational/Controlled Environments:

Are defined as locations where there is exposure that may be incurred by people who are aware of the potential for exposure, (i.e. as a result of employment or occupation).

General Population/Uncontrolled Environments:

Are defined as locations where there is the exposure of individuals who have no knowledge or control of their exposure.

NOTE
 TRUNK LIMIT
 1.6 W/kg
 APPLIED TO THIS EUT

1.2. Statement of Compliance

The maximum results of Specific Absorption Rate (SAR) found during testing for AL152 are as follows.

Band	Max Reported SAR Value(W/kg)
	1-g Bottom surface of the keyboard with 0mm
WLAN 2.4G(DTS)	0.198
WLAN 5.2G(NII)	0.341
WLAN 5.3G(NII)	0.154
WLAN 5.6G(NII)	0.208
WLAN 5.8G(NII)	0.253

Note: This device is in compliance with Specific Absorption Rate (SAR) for general population / uncontrolled exposure limits (1.6 W/kg) specified in FCC 47 CFR Part 2(2.1093), and had been tested in accordance with the measurement methods and procedures specified in IEEE Std 1528-2013 & KDB 865664 D01.

1.3. EUT Description

Device Information			
Product Name	Notebook		
Trade Name	HENA, Azeyo		
Model Name	AL152		
Family Model	CG15Q03P		
Model Difference	All models are the same circuit and RF module, except for model names.		
FCC ID	2A27O-AL152		
Device Phase	Identical Prototype		
Exposure Category	General population / Uncontrolled environment		
Antenna	FPC antenna		
Battery Information	DC 7.6V, 5000mAh		
Hardware version	S8_AW_133R110		
Software version	WINDOWS 11		
Device Operating Configurations			
Supporting Mode(s)	WLAN 2.4G/5G, Bluetooth		
Test Modulation	WLAN(DSSS/OFDM), Bluetooth(GFSK, $\pi/4$ -DQPSK, 8DPSK)		
Device Class	B		
Operating Frequency Range(s)	Band	Tx (MHz)	Rx (MHz)
	WLAN 2.4G	2412-2462	
	WLAN 5.2G	5180-5240	
	WLAN 5.3G	5260-5320	

	WLAN 5.6G	5500-5700
	WLAN 5.8G	5745-5825
	Bluetooth	2402-2480

1.4. Test specification(s)

FCC 47 CFR Part 2(2.1093)
IEEE Std 1528-2013
KDB 865664 D01 SAR measurement 100 MHz to 6 GHz
KDB 865664 D02 RF Exposure Reporting
KDB 447498 D01 General RF Exposure Guidance
KDB 248227 D01 802.11 Wi-Fi SAR
KDB 616217 D04 SAR for laptop and tablets

1.5. Ambient Condition

Ambient temperature	20°C – 24°C
Relative Humidity	30% – 70%

2. SAR Measurement System

2.1. SATIMO SAR Measurement Set-up Diagram

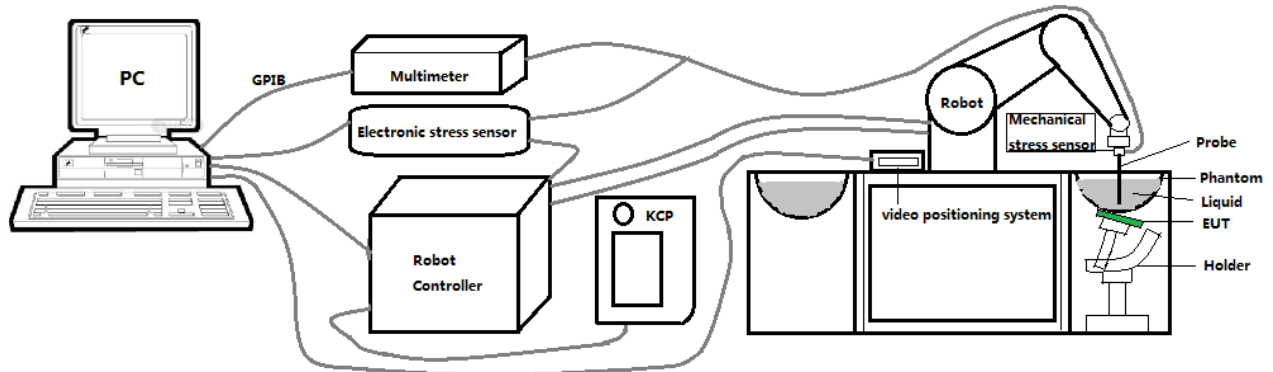

These measurements were performed with the automated near-field scanning system OPENSAR from SATIMO. The system is based on a high precision robot (working range: 901 mm), which positions the probes with a positional repeatability of better than ± 0.03 mm. The SAR measurements were conducted with dosimetric probe (manufactured by SATIMO), designed in the classical triangular configuration and optimized for dosimetric evaluation.

The first step of the field measurement is the evaluation of the voltages induced on the probe by the device under test. Probe diode detectors are nonlinear. Below the diode compression point, the output voltage is proportional to the square of the applied E-field; above the diode compression point, it is linear to the applied E-field. The compression point depends on the diode, and a calibration procedure is necessary for each sensor of the probe.

The Keithley multimeter reads the voltage of each sensor and send these three values to the PC. The corresponding E field value is calculated using the probe calibration factors, which are stored in the working directory. This evaluation includes linearization of the diode characteristics. The field calculation is done separately for each sensor. Each component of the E field is displayed on the "Dipole Area Scan Interface" and the total E field is displayed on the "3D Interface"

2.2. Robot

The SATIMO SAR system uses the high precision robots from KUKA. For the 6-axis controller system, the robot controller version (KUKA) from KUKA is used. The KUKA robot series have many features that are important for our application:



- High precision (repeatability ± 0.03 mm)
- High reliability (industrial design)
- Jerk-free straight movements
- Low ELF interference (the closed metallic construction shields against motor control fields)

2.3. E-Field Probe

This E-field detection probe is composed of three orthogonal dipoles linked to special Schottky diodes with low detection thresholds. The probe allows the measurement of electric fields in liquids such as the one defined in the IEEE and CENELEC standards.

For the measurements the Specific Dosimetric E-Field Probe 3423-EPGO-426 with following specifications is used



- Dynamic range: 0.01-100 W/kg
 - Tip Diameter : 2.5 mm
 - Distance between probe tip and sensor center: 1 mm
 - Distance between sensor center and the inner phantom surface: 2 mm (repeatability better than ± 1 mm).
 - Probe linearity: ± 0.06 dB
 - Axial isotropy: ± 0.01 dB
 - Hemispherical Isotropy: ± 0.01 dB
 - Calibration range: 650MHz to 5900MHz for head & body simulating liquid.
 - Lower detection limit: 8mW/kg
- Angle between probe axis (evaluation axis) and surface normal line: less than 30° .

2.3.1. E-Field Probe Calibration

Each probe needs to be calibrated according to a dosimetric assessment procedure with accuracy better than $\pm 10\%$. The spherical isotropy shall be evaluated and within ± 0.25 dB. The sensitivity parameters (Norm X, Norm Y, and Norm Z), the diode compression parameter (DCP) and the conversion factor (Conv F) of the probe are tested. The calibration data can be referred to appendix D of this report.

2.4. SAM phantoms

Photo of SAM phantom SN 16/15 SAM119



The SAM phantom is used to measure the SAR relative to people exposed to electro-magnetic field radiated by mobile phones.

2.4.1. Technical Data

Serial Number	Shell thickness	Filling volume	Dimensions	Positionner Material	Permittivity	Loss Tangent
SN 16/15 SAM119	2 mm ±0.2 mm	27 liters	Length:1000 mm Width:500 mm Height:200 mm	Gelcoat with fiberglass	3.4	0.02



Serial Number	Left Head(mm)		Right Head(mm)		Flat Part(mm)	
	1	2	1	2	1	2
SN 16/15 SAM119	2	2.02	2	2.08	1	2.09
	3	2.05	3	2.06	2	2.06
	4	2.07	4	2.07	3	2.08
	5	2.08	5	2.08	4	2.10
	6	2.05	6	2.07	5	2.10
	7	2.05	7	2.05	6	2.07
	8	2.07	8	2.06	7	2.07
	9	2.08	9	2.06	-	-

The test, based on ultrasonic system, allows measuring the thickness with an accuracy of 10 µm.

2.5. Device Holder

The positioning system allows obtaining cheek and tilting position with a very good accuracy. In compliance with CENELEC, the tilt angle uncertainty is lower than 1 degree.

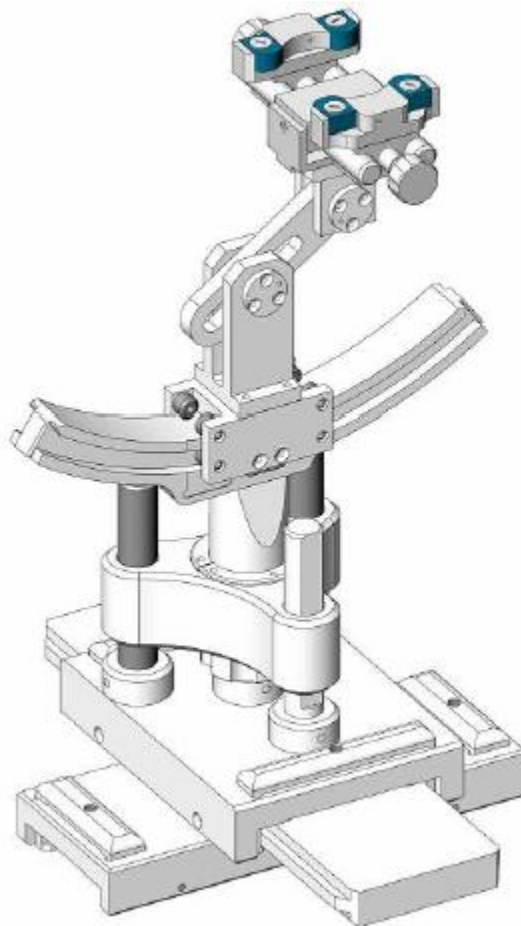

Serial Number	Holder Material	Permittivity	Loss Tangent
SN 16/15 MSH100	Delrin	3.7	0.005

2.6. Test Equipment List

This table gives a complete overview of the SAR measurement equipment.

Devices used during the test described are marked

	Manufacturer	Name of Equipment	Type/Model	Serial Number	Calibration	
					Last Cal.	Due Date
<input checked="" type="checkbox"/>	MVG	E FIELD PROBE	SSE2	3423-EPGO-426	Sep. 18, 2023	Sep. 17, 2024
<input type="checkbox"/>	MVG	750 MHz Dipole	SID750	SN 03/15 DIP 0G750-355	Feb. 21, 2024	Feb. 20, 2027
<input type="checkbox"/>	MVG	835 MHz Dipole	SID835	SN 03/15 DIP 0G835-347	Feb. 21, 2024	Feb. 20, 2027
<input type="checkbox"/>	MVG	900 MHz Dipole	SID900	SN 03/15 DIP 0G900-348	Feb. 21, 2024	Feb. 20, 2027
<input type="checkbox"/>	MVG	1800 MHz Dipole	SID1800	SN 03/15 DIP 1G800-349	Feb. 21, 2024	Feb. 20, 2027
<input type="checkbox"/>	MVG	1900 MHz Dipole	SID1900	SN 03/15 DIP 1G900-350	Feb. 21, 2024	Feb. 20, 2027
<input type="checkbox"/>	MVG	2000 MHz Dipole	SID2000	SN 03/15 DIP 2G000-351	Feb. 21, 2024	Feb. 20, 2027
<input type="checkbox"/>	MVG	2300 MHz Dipole	SID2300	SN 03/16 DIP 2G300-358	Feb. 21, 2024	Feb. 20, 2027
<input checked="" type="checkbox"/>	MVG	2450 MHz Dipole	SID2450	SN 03/15 DIP 2G450-352	Feb. 21, 2024	Feb. 20, 2027
<input type="checkbox"/>	MVG	2600 MHz Dipole	SID2600	SN 03/15 DIP 2G600-356	Feb. 21, 2024	Feb. 20, 2027
<input type="checkbox"/>	MVG	3500 MHz Dipole	SID3500	SN 09/12 DIP 3G500-360	Oct. 15, 2022	Oct. 14, 2025
<input type="checkbox"/>	MVG	3700 MHz Dipole	SID3700	SN 09/12 DIP 3G/700-361	Oct. 15 2022	Oct. 14 2025
<input checked="" type="checkbox"/>	MVG	5000 MHz Dipole	SWG5500	SN 13/14 WGA 33	Feb. 21, 2024	Feb. 20, 2027
<input checked="" type="checkbox"/>	MVG	Liquid measurement Kit	SCLMP	SN 21/15 OCPG 72	NCR	NCR
<input checked="" type="checkbox"/>	MVG	Power Amplifier	N.A	AMPLISAR_28/14_003	NCR	NCR
<input checked="" type="checkbox"/>	KEITHLEY	Millivoltmeter	2000	4072790	NCR	NCR
<input type="checkbox"/>	R&S	Universal radio communication tester	CMU200	117858	Apr. 26, 2024	Apr. 25, 2025

<input type="checkbox"/>	R&S	Wideband radio communication tester	CMW500	103917	Apr. 26, 2024	Apr. 25, 2025
<input checked="" type="checkbox"/>	HP	Network Analyzer	8753D	3410J01136	Apr. 26, 2024	Apr. 25, 2025
<input checked="" type="checkbox"/>	Agilent	MXG Vector Signal Generator	N5182A	MY47070317	Apr. 25, 2024	Apr. 24, 2025
<input checked="" type="checkbox"/>	Agilent	Power meter	E4419B	MY45102538	Apr. 25, 2024	Apr. 24, 2025
<input checked="" type="checkbox"/>	Agilent	Power sensor	E9301A	MY41495644	Apr. 25, 2024	Apr. 24, 2025
<input checked="" type="checkbox"/>	Agilent	Power sensor	E9301A	US39212148	Apr. 25, 2024	Apr. 24, 2025
<input checked="" type="checkbox"/>	MCLI/USA	Directional Coupler	CB11-20	0D2L51502	Apr. 26, 2024	Apr. 25, 2027
<input checked="" type="checkbox"/>	N/A	Thermometer	N/A	LES-085	Mar. 27, 2023	Mar. 26, 2026
<input checked="" type="checkbox"/>	MVG	SAM Phantom	SSM2	SN 16/15 SAM119	NCR	NCR
<input checked="" type="checkbox"/>	MVG	Device Holder	SMPPD	SN 16/15 MSH100	NCR	NCR
<input checked="" type="checkbox"/>	Shenzhen Tianxu Communication Technology Co., Ltd.	Human Simulating Liquid	Head 2450	Head 2450	NCR	NCR

3. SAR Measurement Procedures

The measurement procedures are as follows:

<Conducted power measurement>

- (a) For WWAN power measurement, use base station simulator to configure EUT WWAN transmission in conducted connection with RF cable, at maximum power in each supported wireless interface and frequency band.
- (b) Read the WWAN RF power level from the base station simulator.
- (c) For WLAN/Bluetooth power measurement, use engineering software to configure EUT WLAN/Bluetooth continuously transmission, at maximum RF power in each supported wireless interface and frequency band.
- (d) Connect EUT RF port through RF cable to the power meter, and measure WLAN/Bluetooth output power.

<SAR measurement>

- (a) Use base station simulator to configure EUT WWAN transmission in radiated connection, and engineering software to configure EUT WLAN/Bluetooth continuously transmission, at maximum RF power, in the highest power channel.
- (b) Place the EUT in the positions as Appendix A demonstrates.
- (c) Set scan area, grid size and other setting on the OPENSAR software.
- (d) Measure SAR results for the highest power channel on each testing position.
- (e) Find out the largest SAR result on these testing positions of each band.
- (f) Measure SAR results for other channels in worst SAR testing position if the reported SAR of highest power channel is larger than 0.8 W/kg.

According to the test standard, the recommended procedure for assessing the peak spatial-average SAR value consists of the following steps:

- (a) Power reference measurement
- (b) Area scan
- (c) Zoom scan
- (d) Power drift measurement

3.1. Power Reference

The Power Reference Measurement and Power Drift Measurements are for monitoring the power drift of the device under test in the batch process. The minimum distance of probe sensors to surface determines the closest measurement point to phantom surface. This distance cannot be smaller than the distance of sensor calibration points to probe tip as defined in the probe properties.

3.2. Area scan & Zoom scan

The area scan is a 2D scan to find the hot spot location on the DUT. The zoom scan is a 3D scan above the hot spot to calculate the 1g and 10g SAR value.

Measurement of the SAR distribution with a grid of 8 to 16 mm * 8 to 16 mm and a constant distance to the inner surface of the phantom. Since the sensors cannot directly measure at the inner phantom surface, the values between the sensors and the inner phantom surface are extrapolated. With these values the area of the maximum SAR is calculated by an interpolation scheme. Around this point, a cube of 30 * 30 * 30 mm or 32 * 32 * 32 mm is assessed by measuring 5 or 8 * 5 or 8 * 4 or 5 mm. With these data, the peak spatial-average SAR value can be calculated.

From the scanned SAR distribution, identify the position of the maximum SAR value, in addition identify the positions of any local maxima with SAR values within 2 dB of the maximum value that will not be within the zoom scan of other peaks; additional peaks shall be measured only when the primary peak is within 2 dB of the SAR compliance limit (e.g., 1 W/kg for 1,6 W/kg 1 g limit, or 1,26 W/kg for 2 W/kg, 10 g limit).

Area scan & Zoom scan scan parameters extracted from FCC KDB 865664 D01 SAR measurement 100 MHz to 6 GHz.

		≤ 3 GHz	> 3 GHz	
Maximum distance from closest measurement point (geometric center of probe sensors) to phantom surface		5 ± 1 mm	½·δ·ln(2) ± 0.5 mm	
Maximum probe angle from probe axis to phantom surface normal at the measurement location		30° ± 1°	20° ± 1°	
Maximum area scan spatial resolution: Δx _{Area} , Δy _{Area}		≤ 2 GHz: ≤ 15 mm 2 – 3 GHz: ≤ 12 mm	3 – 4 GHz: ≤ 12 mm 4 – 6 GHz: ≤ 10 mm	
		When the x or y dimension of the test device, in the measurement plane orientation, is smaller than the above, the measurement resolution must be ≤ the corresponding x or y dimension of the test device with at least one measurement point on the test device.		
Maximum zoom scan spatial resolution: Δx _{Zoom} , Δy _{Zoom}		≤ 2 GHz: ≤ 8 mm 2 – 3 GHz: ≤ 5 mm*	3 – 4 GHz: ≤ 5 mm* 4 – 6 GHz: ≤ 4 mm*	
Maximum zoom scan spatial resolution, normal to phantom surface	uniform grid: Δz _{Zoom} (n)	≤ 5 mm	3 – 4 GHz: ≤ 4 mm 4 – 5 GHz: ≤ 3 mm 5 – 6 GHz: ≤ 2 mm	
	graded grid	Δz _{Zoom} (1): between 1 st two points closest to phantom surface	≤ 4 mm	3 – 4 GHz: ≤ 3 mm 4 – 5 GHz: ≤ 2.5 mm 5 – 6 GHz: ≤ 2 mm
		Δz _{Zoom} (n>1): between subsequent points	≤ 1.5·Δz _{Zoom} (n-1)	
Minimum zoom scan volume	x, y, z	≥ 30 mm	3 – 4 GHz: ≥ 28 mm 4 – 5 GHz: ≥ 25 mm 5 – 6 GHz: ≥ 22 mm	

Note: δ is the penetration depth of a plane-wave at normal incidence to the tissue medium; see draft standard IEEE P1528-2011 for details.

* When zoom scan is required and the *reported* SAR from the *area scan based 1-g SAR estimation* procedures of KDB 447498 is ≤ 1.4 W/kg, ≤ 8 mm, ≤ 7 mm and ≤ 5 mm zoom scan resolution may be applied, respectively, for 2 GHz to 3 GHz, 3 GHz to 4 GHz and 4 GHz to 6 GHz.

3.3. Description of interpolation/extrapolation scheme

The local SAR inside the phantom is measured using small dipole sensing elements inside a probe body. The probe tip must not be in contact with the phantom surface in order to minimise measurements errors, but the highest local SAR will occur at the surface of the phantom.

An extrapolation is used to determine these highest local SAR values. The extrapolation is based on a fourth-order least-square polynomial fit of measured data. The local SAR value is then extrapolated from the liquid surface with a 1 mm step.

The measurements have to be performed over a limited time (due to the duration of the battery) so the step of measurement is high. It could vary between 5 and 8 mm. To obtain an accurate assessment of the maximum SAR averaged over 10 grams and 1 gram requires a very fine resolution in the three dimensional scanned data array.

3.4. Volumetric Scan

The volumetric scan consists of a full 3D scan over a specific area. This 3D scan is useful for multi Tx SAR measurement. Indeed, it is possible with OpenSAR to add, point by point, several volumetric scans to calculate the SAR value of the combined measurement as it is defined in the standard IEEE1528 and IEC62209.

3.5. Power Drift

All SAR testing is under the EUT installed with a full charged battery and transmit maximum output power. In OpenSAR measurement software, the power reference measurement and power drift measurement procedures are used for monitoring the power drift of EUT during SAR test. Both these procedures measure the field at a specified reference position before and after the SAR testing. The software will calculate the field difference in V/m. If the power drifts more than $\pm 5\%$, the SAR will be retested.

4. System Verification Procedure

4.1. Tissue Verification

The following tissue formulations are provided for reference only as some of the parameters have not been thoroughly verified. The composition of ingredients may be modified accordingly to achieve the desired target tissue parameters required for routine SAR evaluation.

Ingredients (% of weight)	Head Tissue									
	750	835	900	1800	1900	2000	2450	2600	5200	5800
Frequency Band (MHz)										
Water	34.40	34.40	34.40	55.36	55.36	57.87	57.87	57.87	65.53	65.53
NaCl	0.79	0.79	0.79	0.35	0.35	0.16	0.16	0.16	0.00	0.00
1,2-Propanediol	64.81	64.81	64.81	0.00	0.00	0.00	0.00	0.00	0.00	0.00
Triton X-100	0.00	0.00	0.00	30.45	30.45	19.97	19.97	19.97	24.24	24.24
DGBE	0.00	0.00	0.00	13.84	13.84	22.00	22.00	22.00	10.23	10.23
Ingredients (% of weight)	Body Tissue									
	750	835	900	1800	1900	2000	2450	2600	5200	5800
Frequency Band (MHz)										
Water	50.30	50.30	50.30	69.91	69.91	71.88	71.88	71.88	79.54	79.54
NaCl	0.60	0.60	0.60	0.13	0.13	0.16	0.16	0.16	0.00	0.00
1,2-Propanediol	49.10	49.10	49.10	0.00	0.00	0.00	0.00	0.00	0.00	0.00
Triton X-100	0.00	0.00	0.00	9.99	9.99	19.97	19.97	19.97	11.24	11.24
DGBE	0.00	0.00	0.00	19.97	19.97	7.99	7.99	7.99	9.22	9.22

For SAR measurement of the field distribution inside the phantom, the phantom must be filled with homogeneous tissue simulating liquid to a depth of at least 15 cm. For head SAR testing, the liquid depth from the ear reference point (ERP) of the phantom to the liquid top surface is larger than 15 cm.

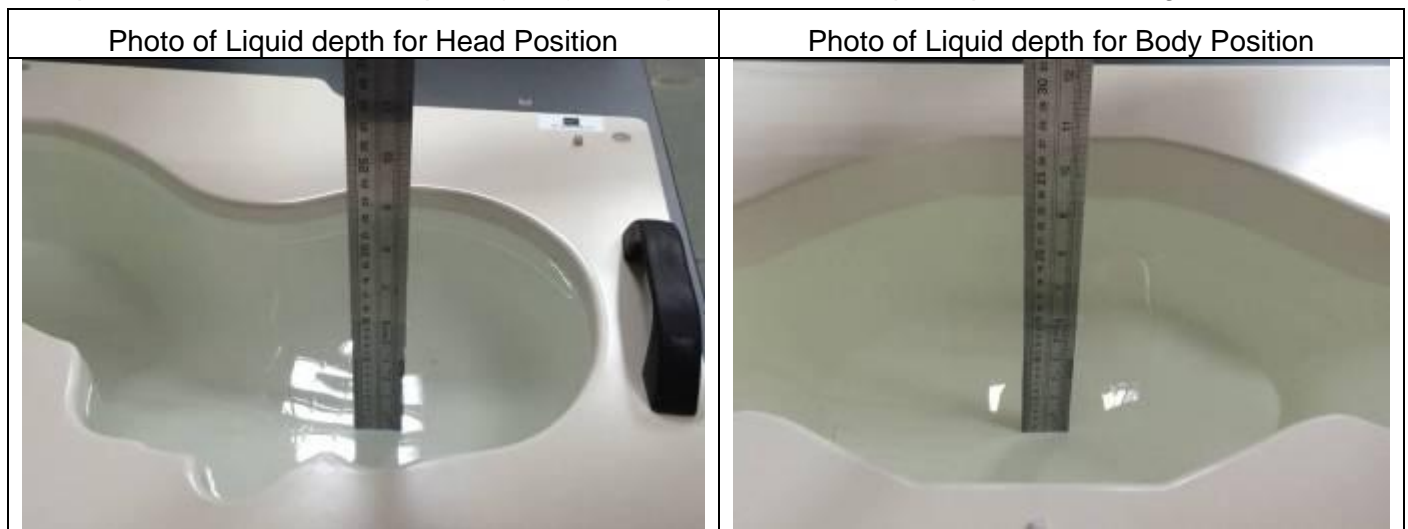

4.1.1. Tissue Dielectric Parameter Check Results

The simulating liquids should be checked at the beginning of a series of SAR measurements to determine if the dielectric parameters are within the tolerances of the specified target values. The measured conductivity and relative permittivity should be within $\pm 5\%$ of the target values.

Tissue Type	Measured Frequency (MHz)	Target Tissue		Measured Tissue		Liquid Temp.	Test Date
		ϵ_r ($\pm 5\%$)	σ (S/m) ($\pm 5\%$)	ϵ_r	σ (S/m)		
Head 2450	2450	39.20 (37.24~41.16)	1.80 (1.71~1.89)	37.69	1.77	21.5 °C	Jul. 05, 2024
Head 5200	5200	36.00 (34.20~37.80)	4.66 (4.43~4.89)	34.73	4.56	21.5 °C	Jun. 25, 2024
Head 5400	5400	35.80 (34.01~37.59)	4.86 (4.62~5.10)	34.43	4.85	21.8 °C	Jul. 03, 2024
Head 5600	5600	35.50 (33.73~37.28)	5.07 (4.82~5.32)	34.50	4.98	21.6 °C	Jul. 04, 2024
Head 5800	5800	35.30 (33.54~37.07)	5.27 (5.01~5.53)	34.16	5.21	21.9 °C	Jun. 26, 2024

NOTE: The dielectric parameters of the tissue-equivalent liquid should be measured under similar ambient conditions and within 2 °C of the conditions expected during the SAR evaluation to satisfy protocol requirements.

4.2. System Verification Procedure

The system verification is performed for verifying the accuracy of the complete measurement system and performance of the software. The dipole is connected to the signal source consisting of signal generator and amplifier via a directional coupler, N-connector cable and adaption to SMA. It is fed with a power of 100mW (below 5GHz) or 100mW (above 5GHz). To adjust this power a power meter is used. The power sensor is connected to the cable before the system verification to measure the power at this point and do adjustments at the signal generator. At the outputs of the directional coupler both return loss as well as forward power are controlled during the system verification to make sure that emitted power at the dipole is kept constant. This can also be checked by the power drift measurement after the test (result on plot).

The system verification is shown as below picture:

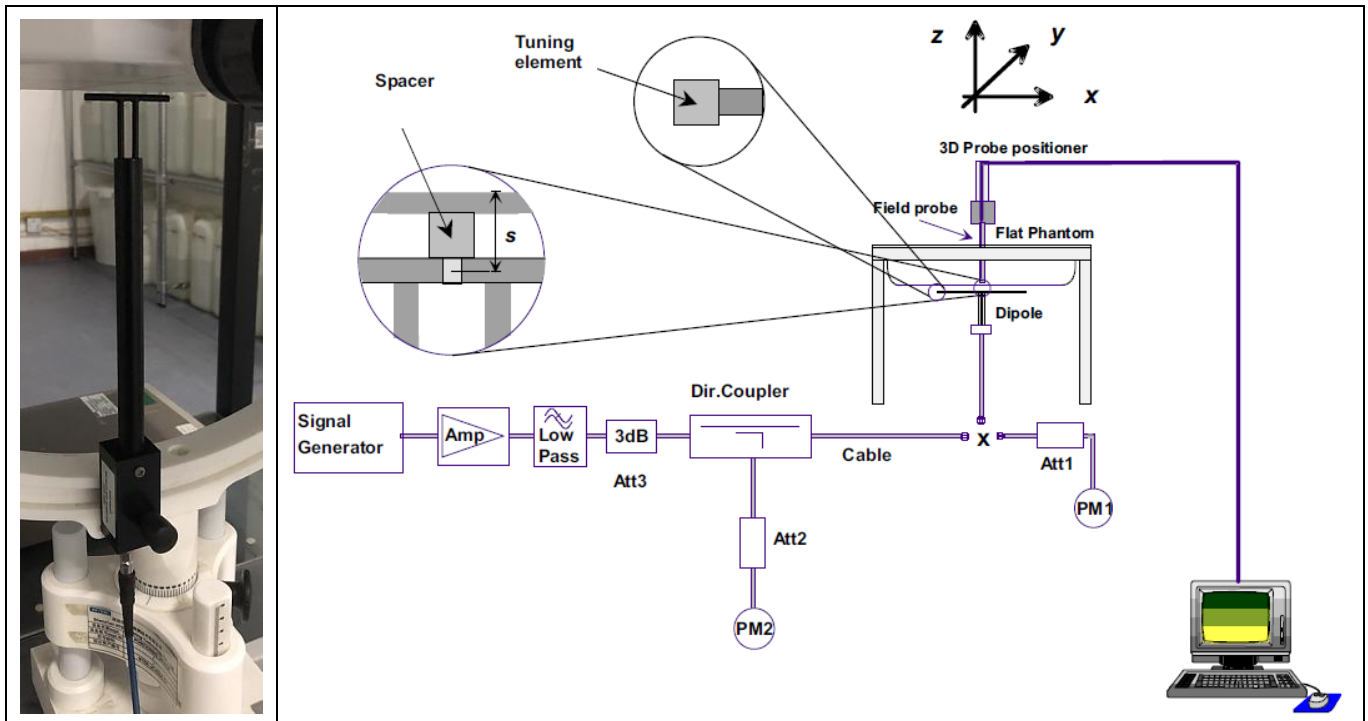

4.2.1. System Verification Results

Comparing to the original SAR value provided by SATIMO, the verification data should be within its specification of $\pm 10\%$. Below table shows the target SAR and measured SAR after normalized to 1W input power. The table below indicates the system performance verification can meet the variation criterion and the plots can be referred to Appendix B of this report.

System Verification	Target SAR (1W)		Measured SAR		Liquid Temp.	Test Date
	($\pm 10\%$)		(Normalized to 1W)			
	1-g (W/Kg)	10-g (W/Kg)	1-g (W/Kg)	10-g (W/Kg)		
2450MHz	50.05 (45.05~55.06)	23.80 (21.42~26.18)	47.91	25.16	21.5 °C	Jul. 05, 2024
5200MHz	162.59 (146.33~178.85)	56.21 (50.59~61.83)	149.35	54.11	21.5 °C	Jun. 25, 2024
5400MHz	159.81 (143.83~175.79)	55.00 (49.50~60.50)	172.59	57.69	21.8 °C	Jul. 03, 2024
5600MHz	179.15 (161.24~197.07)	61.01 (54.91~67.11)	172.55	62.81	21.6 °C	Jul. 04, 2024
5800MHz	182.20 (163.98~200.42)	61.32 (55.19~67.45)	182.53	63.09	21.9 °C	Jun. 26, 2024

5. SAR Measurement variability and uncertainty

5.1. SAR measurement variability

Per KDB865664 D01 SAR measurement 100 MHz to 6 GHz, SAR measurement variability must be assessed for each frequency band, which is determined by the SAR probe calibration point and tissue-equivalent medium used for the device measurements. The additional measurements are repeated after the completion of all measurements requiring the same head or body tissue-equivalent medium in a frequency band. The test device should be returned to ambient conditions (normal room temperature) with the battery fully charged before it is re-mounted on the device holder for the repeated measurement(s) to minimize any unexpected variations in the repeated results.

- 1) Repeated measurement is not required when the original highest measured SAR is < 0.80 W/kg; steps 2) through 4) do not apply.
- 2) When the original highest measured SAR is ≥ 0.80 W/kg, repeat that measurement once.
- 3) Perform a second repeated measurement only if the ratio of largest to smallest SAR for the original and first repeated measurements is > 1.20 or when the original or repeated measurement is ≥ 1.45 W/kg (~ 10% from the 1-g SAR limit).
- 4) Perform a third repeated measurement only if the original, first or second repeated measurement is ≥ 1.5 W/kg and the ratio of largest to smallest SAR for the original, first and second repeated measurements is > 1.20 .

5.2. SAR measurement uncertainty

Per KDB865664 D01 SAR Measurement 100 MHz to 6 GHz, when the highest measured 1-g SAR within a frequency band is < 1.5 W/kg, the extensive SAR measurement uncertainty analysis described in IEEE Std 1528-2013 is not required in SAR reports submitted for equipment approval. The equivalent ratio (1.5/1.6) is applied to extremity and occupational exposure conditions.

6. RF Exposure Positions

6.1. Laptop host platform test requirements

The required minimum test separation distance for incorporating transmitters and antennas into laptop, notebook and netbook computer displays is determined with the display screen opened at an angle of 90° to the keyboard compartment. When antennas are incorporated in the keyboard section of a laptop computer, SAR is required for the bottom surface of the keyboard. Provided tablet use conditions are not supported by the laptop computer, SAR tests for bystander exposure from the edges of the keyboard and display screen of laptop computers are generally not required.

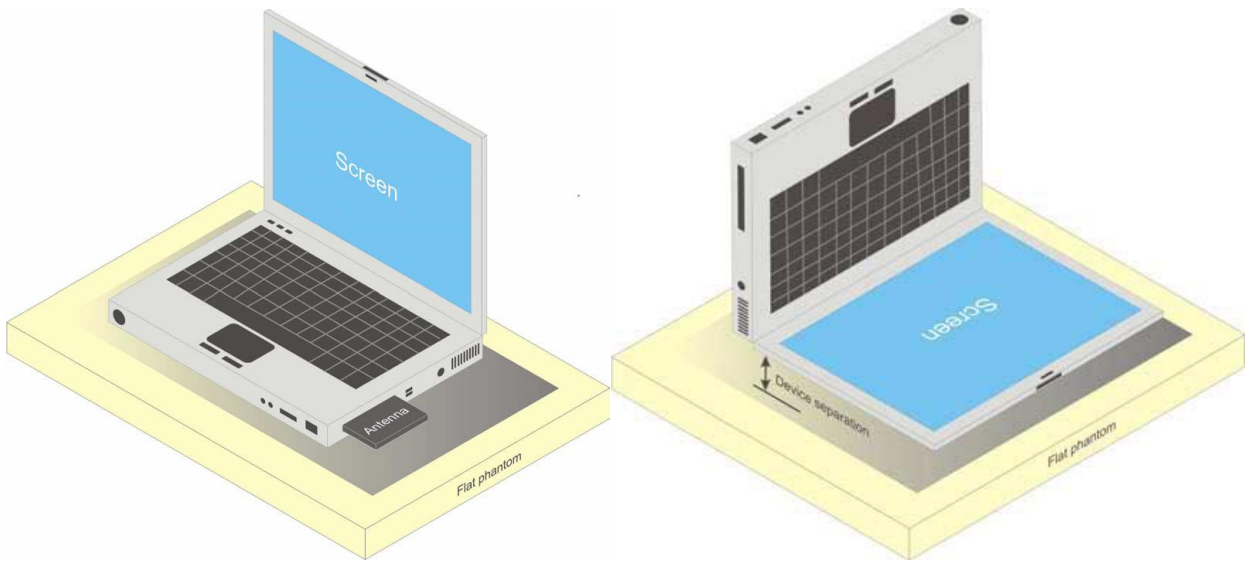

Figure 6.1 – Test positions for Laptop

7. RF Output Power

7.1. WLAN & Bluetooth Output Power

7.1.1. Output Power Results Of WLAN

Mode	Channel	Frequency (MHz)	Tune-up	Output Power (dBm)ANT1	Tune-up	Output Power (dBm)ANT2
802.11b	1	2412	16.00	15.97	16.50	16.18
	6	2437	16.00	15.98	16.50	16.23
	11	2462	16.00	15.54	16.50	16.01
802.11g	1	2412	15.50	15.33	16.00	15.58
	6	2437	15.50	15.12	16.00	15.51
	11	2462	15.50	14.60	16.00	14.98
802.11n (HT20)	1	2412	15.50	15.37	16.00	15.72
	6	2437	15.50	15.16	16.00	15.55
	11	2462	15.50	14.51	16.00	15.02
802.11n (HT40)	3	2422	16.00	15.96	16.50	16.17
	6	2437	16.00	15.65	16.50	16.08
	9	2452	16.00	15.41	16.50	15.81

NOTE: Power measurement results of WLAN 2.4G.

Mode	Channel	Frequency (MHz)	Tune-up	Output Power (dBm)ANT1	Tune-up	Output Power (dBm)ANT2
802.11a	36	5180	9.00	7.65	8.50	7.82
	40	5200	9.00	8.19	8.50	8.22
	48	5240	9.00	8.65	8.50	8.41
802.11n HT20	36	5180	7.00	6.34	8.50	8.22
	40	5200	8.50	8.22	8.50	7.58
	48	5240	8.50	8.27	8.50	8.49
802.11n HT40	38	5190	7.50	6.67	7.50	7.14
	46	5230	7.50	7.37	7.50	7.49
802.11ac VHT20	36	5180	8.00	7.13	9.50	7.77
	40	5200	8.00	7.53	9.50	7.68
	48	5240	8.00	7.97	9.50	9.03
802.11ac VHT40	38	5190	7.50	6.19	8.00	6.90
	46	5230	7.50	7.14	8.00	7.75

802.11ac VHT80	42	5210	5.50	5.25	6.00	5.61
-------------------	----	------	------	------	------	------

NOTE: Power measurement results of WLAN 5.2G.

Mode	Channel	Frequency (MHz)	Tune-up	Output Power (dBm)ANT1	Tune-up	Output Power (dBm)ANT2
802.11a	52	5260	8.50	8.18	9.00	8.21
	56	5280	8.50	8.17	9.00	8.76
	64	5320	8.50	8.35	9.00	8.52
802.11n HT20	52	5260	9.00	7.73	9.00	7.97
	56	5280	9.00	8.75	9.00	8.06
	64	5320	9.00	8.89	9.00	8.89
802.11n HT40	54	5270	8.00	7.31	7.50	6.92
	62	5310	8.00	7.87	7.50	7.32
802.11ac VHT20	52	5260	9.00	7.85	9.00	7.68
	56	5280	9.00	8.83	9.00	8.20
	64	5320	9.00	8.84	9.00	8.86
802.11ac VHT40	54	5270	8.00	6.73	7.50	6.95
	62	5310	8.00	7.73	7.50	7.43
802.11ac VHT80	58	5290	4.50	4.47	5.00	4.71

NOTE: Power measurement results of WLAN 5.3G.

Mode	Channel	Frequency (MHz)	Tune-up	Output Power (dBm)ANT1	Tune-up	Output Power (dBm)ANT2
802.11a	100	5500	9.00	8.54	8.50	7.96
	120	5600	9.00	7.97	8.50	7.57
	140	5700	9.00	8.62	8.50	8.22
802.11 n20	100	5500	8.50	8.21	8.50	7.96
	120	5600	8.50	8.03	8.50	7.73
	140	5700	8.50	7.86	8.50	8.16
802.11 n40	102	5510	8.00	7.74	7.50	6.76
	118	5590	8.00	7.14	7.50	7.39
	134	5670	8.00	6.91	7.50	7.01
802.11ac (VHT20)	100	5500	8.50	8.26	8.50	8.28
	120	5600	8.50	7.98	8.50	8.32
	140	5700	8.50	8.03	8.50	8.11
802.11ac	102	5510	8.00	7.35	7.50	7.11

(VHT40)	118	5590	8.00	7.05	7.50	6.73
	134	5670	8.00	7.53	7.50	7.04
802.11ac	106	5530	5.50	5.37	5.50	4.73
(VHT80)	122	5610	5.50	5.21	5.50	5.03

NOTE: Power measurement results of WLAN 5.6G.

Mode	Channel	Frequency (MHz)	Tune-up	Output Power (dBm)ANT1	Tune-up	Output Power (dBm)ANT2
802.11a	149	5745	9.00	8.66	9.00	8.32
	157	5785	9.00	8.87	9.00	8.71
	165	5825	9.00	8.68	9.00	8.01
802.11n HT20	149	5745	9.50	8.69	8.50	7.93
	157	5785	9.50	9.17	8.50	8.06
	165	5825	9.50	8.17	8.50	8.07
802.11n HT40	151	5755	8.00	7.56	8.00	7.31
	159	5795	8.00	7.52	8.00	7.58
802.11ac VHT20	149	5745	9.00	8.81	9.00	8.56
	157	5785	9.00	8.16	9.00	8.84
	165	5825	9.00	8.21	9.00	8.52
802.11ac VHT40	151	5755	8.00	7.93	7.50	7.46
	159	5795	8.00	7.98	7.50	7.32
802.11ac VHT80	155	5775	5.50	5.40	6.00	5.72

NOTE: Power measurement results of WLAN 5.8G.

BR+EDR	Output Power (dBm)				
	Channel	Tune-up (dBm)	Data Rates		
			1M	2M	3M
	0CH	6.00	5.03	5.16	5.51
	39CH	6.00	5.26	5.27	5.61
	78CH	5.00	4.42	4.40	4.82

BLE	Channel	Tune-up	Output Power (dBm)
			1M
	0CH	6.00	5.53
	19CH	6.00	5.64
	39CH	5.00	4.77

NOTE: Power measurement results of Bluetooth.

8. Stand-alone SAR test exclusion

Refer to FCC KDB 447498D01, the 1-g SAR and 10-g SAR test exclusion thresholds for 100 MHz to 6 GHz at test separation distances ≤ 50 mm are determined by:

$[(\text{max. power of channel, including tune-up tolerance, mW}) / (\text{min. test separation distance, mm})] \cdot [\sqrt{f_{(\text{GHz})}}] \leq 3.0$ for 1-g SAR and ≤ 7.5 for 10-g extremity SAR, where:

- $f_{(\text{GHz})}$ is the RF channel transmit frequency in GHz
- Power and distance are rounded to the nearest mW and mm before calculation
- The result is rounded to one decimal place for comparison

When the minimum test separation distance is < 5 mm, a distance of 5 mm is applied to determine SAR test exclusion.

Mode	P_{max} (dBm)	P_{max} (mW)	Distance (mm)	f (GHz)	Calculation Result	SAR Exclusion threshold	SAR test exclusion
Bluetooth	6.00	3.98	5	2.480	1.2	3.0	Yes

NOTE: Standalone SAR test exclusion for Bluetooth.

When standalone SAR test exclusion applies to an antenna that transmits simultaneously with other antennas, the standalone SAR must be estimated according to following to determine simultaneous transmission SAR test exclusion:

$[(\text{max. power of channel, including tune-up tolerance, mW}) / (\text{min. test separation distance, mm})] \cdot [\sqrt{f_{(\text{GHz})} / x}] \text{ W/kg}$ for test separation distances ≤ 50 mm, where $x = 7.5$ for 1-g SAR and $x = 18.75$ for 10-g SAR.

When the minimum test separation distance is < 5 mm, a distance of 5 mm is applied to determine SAR test exclusion.

Mode	Position	P_{max} (dBm)	P_{max} (mW)	Distance (mm)	f (GHz)	x	Estimated SAR (W/Kg)
Bluetooth	Body	6.00	3.98	5	2.48	7.5	0.167

NOTE: Estimated SAR calculation for Bluetooth

9. SAR Results

9.1. SAR measurement results

9.1.1. SAR measurement Result of WLAN 2.4G

ANT1

Test Position	Test channel /Freq.	Mode	SAR Value (W/kg)		Power Drift(%)	Conducted Power (dBm)	Tune-up Power (dBm)	Scaled SAR 1-g (W/Kg)	Date	Plot
			1-g	10-g						
Bottom surface of the keyboard with	6/2437	802.11b	0.109	0.065	-1.73	15.98	16.00	0.110	2024/7/05	9#

Bottom surface of the keyboard with 0mm	62/5310	802.11n HT40	0.151	0.078	1.49	11.92	12.00	0.154	62/5310	3#
---	---------	--------------	-------	-------	------	-------	-------	-------	---------	----

NOTE: Body SAR test results of WLAN 5.3G

ANT2

Test Position	Test channel /Freq.	Mode	SAR Value (W/kg)		Power Drift(%)	Conducted Power (dBm)	Tune-up Power (dBm)	Scaled SAR 1-g (W/Kg)	Date	Plot
			1-g	10-g						
Bottom surface of the keyboard with 0mm	64/5320	802.11a	0.087	0.051	-3.39	11.92	12.00	0.089	64/5320	4#

NOTE: Body SAR test results of WLAN 5.3G

9.1.4. SAR measurement Result of WLAN 5.6G

ANT1

Test Position	Test channel /Freq.	Mode	SAR Value (W/kg)		Power Drift(%)	Conducted Power (dBm)	Tune-up Power (dBm)	Scaled SAR 1-g (W/Kg)	Date	Plot
			1-g	10-g						
Bottom surface of the keyboard with 0mm	102/5510	802.11n HT40	0.199	0.099	-3.29	11.81	12.00	0.208	2024/7/04	5#

NOTE: Body SAR test results of WLAN 5.6G

ANT2

Test Position	Test channel /Freq.	Mode	SAR Value (W/kg)		Power Drift(%)	Conducted Power (dBm)	Tune-up Power (dBm)	Scaled SAR 1-g (W/Kg)	Date	Plot
			1-g	10-g						
Bottom surface of the keyboard with 0mm	120/5600	802.11n HT40	0.096	0.060	4.40	11.46	11.50	0.097	2024/7/04	6#

NOTE: Body SAR test results of WLAN 5.6G

9.1.5. SAR measurement Result of WLAN 5.8G

ANT1

Test Position	Test channel /Freq.	Mode	SAR Value (W/kg)		Power Drift(%)	Conducted Power (dBm)	Tune-up Power (dBm)	Scaled SAR 1-g (W/Kg)	Date	Plot
			1-g	10-g						
Bottom surface of the keyboard with 0mm	159/5795	802.11ac VHT40	0.227	0.112	2.70	12.03	12.50	0.253	2024/6/26	7#

NOTE: Body SAR test results of WLAN 5.8G

ANT2

Test Position	Test channel /Freq.	Mode	SAR Value (W/kg)		Power Drift(%)	Conducted Power (dBm)	Tune-up Power (dBm)	Scaled SAR 1-g (W/Kg)	Date	Plot
			1-g	10-g						
Bottom surface of the keyboard with 0mm	155/5775	802.11ac VHT80	0.128	0.076	3.79	12.17	12.50	0.138	2024/6/26	8#

NOTE: Body SAR test results of WLAN 5.8G

9.2. Simultaneous Transmission Analysis

NO simultaneous transmissions are possible for this device of Bluetooth, 2.4G/5G Wi-Fi. ANT1 and ANT2 do not support MIMO

10. Appendix A. Photo documentation

Refer to appendix Test Setup photo---SAR

11. Appendix B. System Check Plots

Table of contents
MEASUREMENT 1 System Performance Check - 2450MHz
MEASUREMENT 2 System Performance Check - 5200MHz
MEASUREMENT 3 System Performance Check - 5400MHz
MEASUREMENT 4 System Performance Check - 5600MHz
MEASUREMENT 5 System Performance Check - 5800MHz

MEASUREMENT 1

Date of measurement: 5/7/2024

A. Experimental conditions.

Area Scan	<u>dx=12mm dy=12mm, h= 5.00 mm</u>
ZoomScan	<u>7x7x7, dx=5mm dy=5mm dz=5mm</u>
Phantom	<u>Validation plane</u>
Device Position	<u>Dipole</u>
Band	<u>CW2450</u>
Channels	<u>Middle</u>
Signal	<u>CW (Crest factor: 1.0)</u>
ConvF	<u>2.85</u>

B. SAR Measurement Results

Frequency (MHz)	2450.000000
Relative permittivity (real part)	37.691465
Relative permittivity (imaginary part)	12.968121
Conductivity (S/m)	1.765105
Variation (%)	1.770000

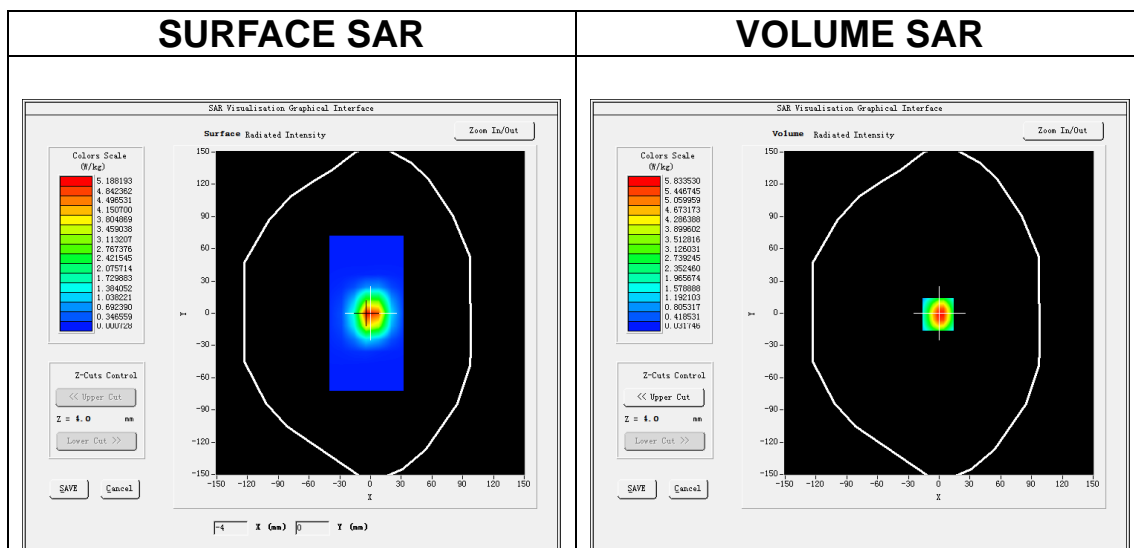

Maximum location: X=-1.00, Y=-1.00
SAR Peak: 9.83 W/kg

SAR 10g (W/Kg)	2.516267
SAR 1g (W/Kg)	4.791338

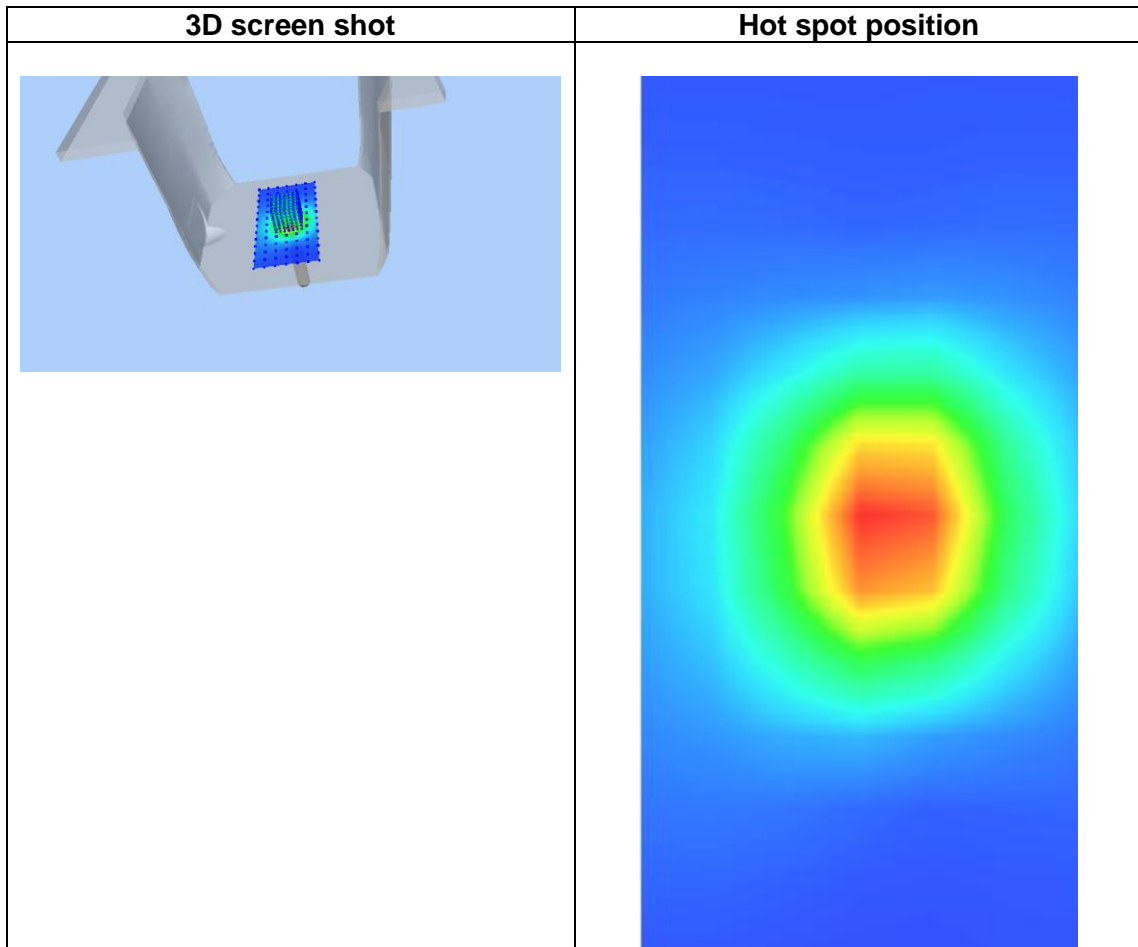
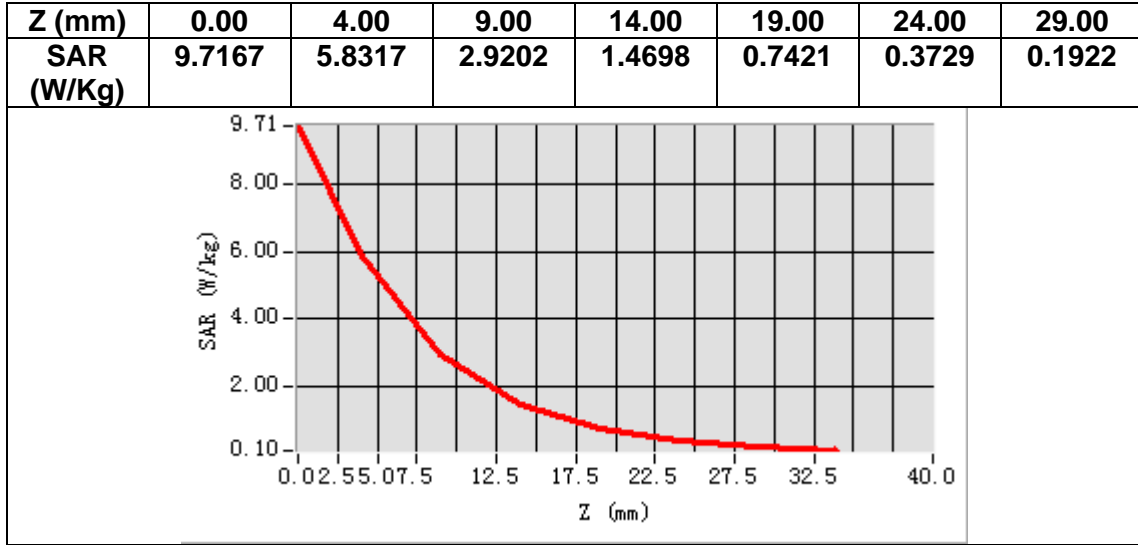

MEASUREMENT 2

Date of measurement: 25/6/2024

A. Experimental conditions.

Area Scan	<u>dx=10mm dy=10mm, h= 2.00 mm</u>
ZoomScan	<u>7x7x12,dx=4mm dy=4mm dz=2mm</u>
Phantom	<u>Validation plane</u>
Device Position	<u>Dipole</u>
Band	<u>CW5200</u>
Channels	<u>Middle</u>
Signal	<u>CW (Crest factor: 1.0)</u>
ConvF	<u>2.07</u>

B. SAR Measurement Results

Frequency (MHz)	5200.000000
Relative permittivity (real part)	34.725906
Relative permittivity (imaginary part)	15.795970
Conductivity (S/m)	4.563280
Variation (%)	1.750000

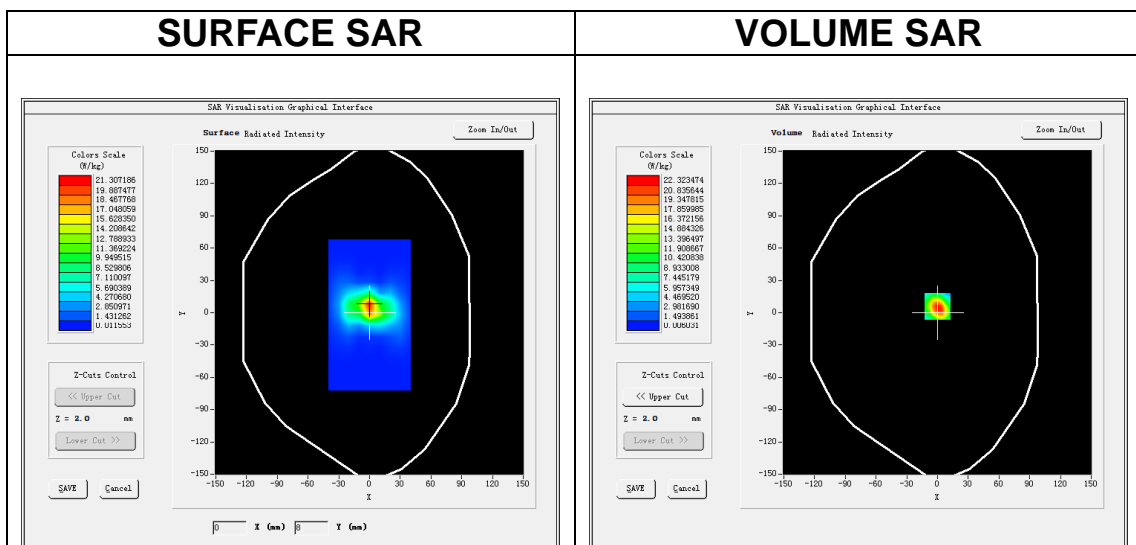

Maximum location: X=0.00, Y=6.00

SAR Peak: 40.06 W/kg

SAR 10g (W/Kg)	5.411331
SAR 1g (W/Kg)	14.935173

Z (m m)	0.00	2.00	4.00	6.00	8.00	10.0	12.0	14.0	16.0	18.0	20.0	22.0
SAR (W/ Kg)	37.8 82	22.3 35	11.3 32	5.66 56	2.82 10	1.40 68	0.71 64	0.36 14	0.18 97	0.10 34	0.05 56	0.03 06

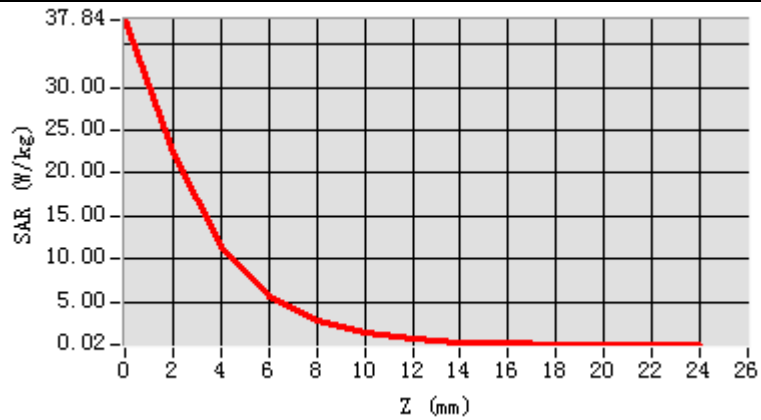

3D screen shot

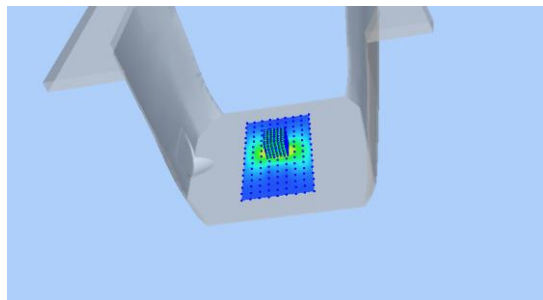

Hot spot position

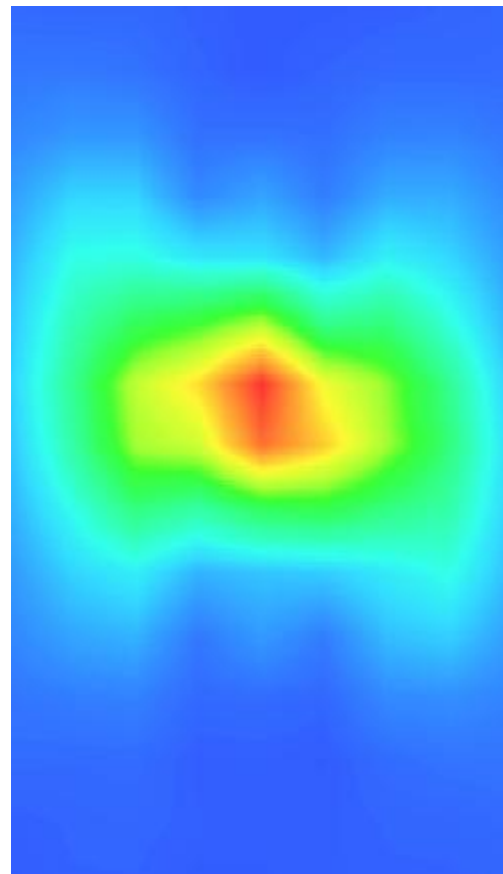

MEASUREMENT 3

Date of measurement: 3/7/2024

A. Experimental conditions.

Area Scan	<u>dx=10mm dy=10mm, h= 2.00 mm</u>
ZoomScan	<u>7x7x12,dx=4mm dy=4mm dz=2mm</u>
Phantom	<u>Validation plane</u>
Device Position	<u>Dipole</u>
Band	<u>CW5400</u>
Channels	<u>Middle</u>
Signal	<u>CW (Crest factor: 1.0)</u>
ConvF	<u>2.11</u>

B. SAR Measurement Results

Frequency (MHz)	5400.000000
Relative permittivity (real part)	34.434748
Relative permittivity (imaginary part)	16.158551
Conductivity (S/m)	4.847565
Variation (%)	-0.700000

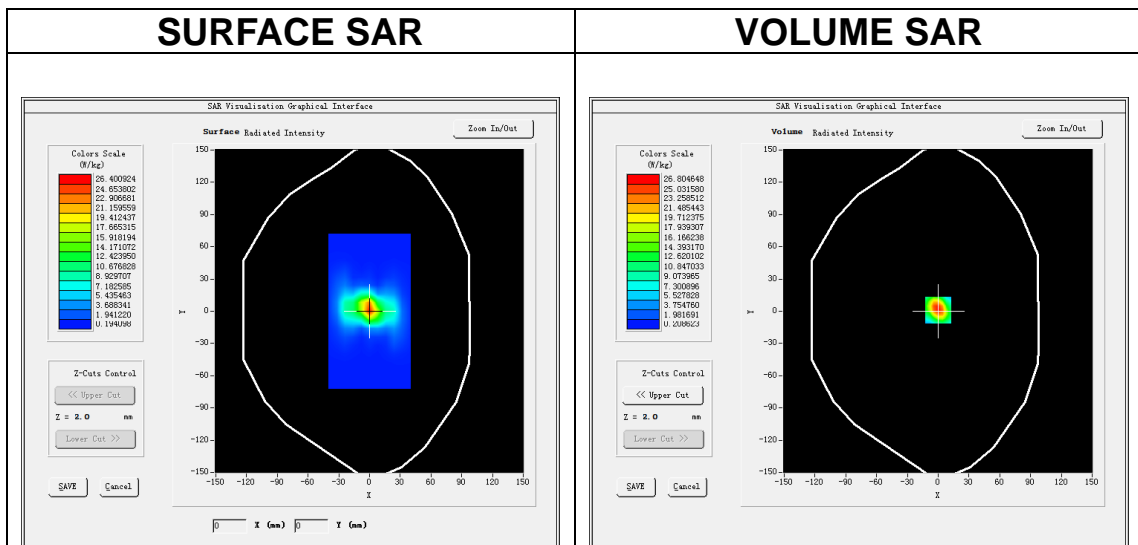

Maximum location: X=0.00, Y=1.00
SAR Peak: 46.18 W/kg

SAR 10g (W/Kg)	5.769369
SAR 1g (W/Kg)	17.259356

Z (m m)	0.00	2.00	4.00	6.00	8.00	10.00	12.00	14.00	16.00	18.00	20.00	22.00
SAR (W/Kg)	44.074	26.875	14.612	7.8109	4.2226	2.3238	1.3237	0.7813	0.5004	0.3745	0.2803	0.2613

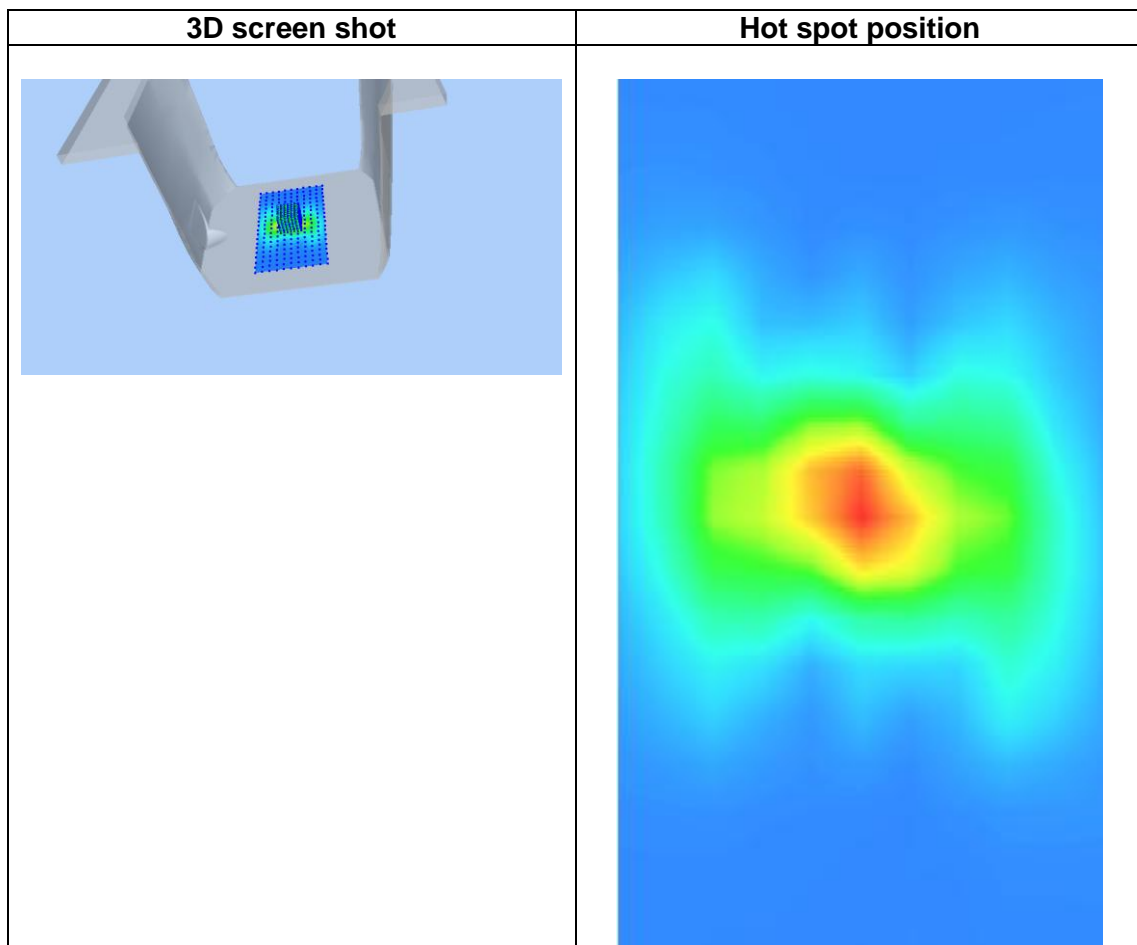
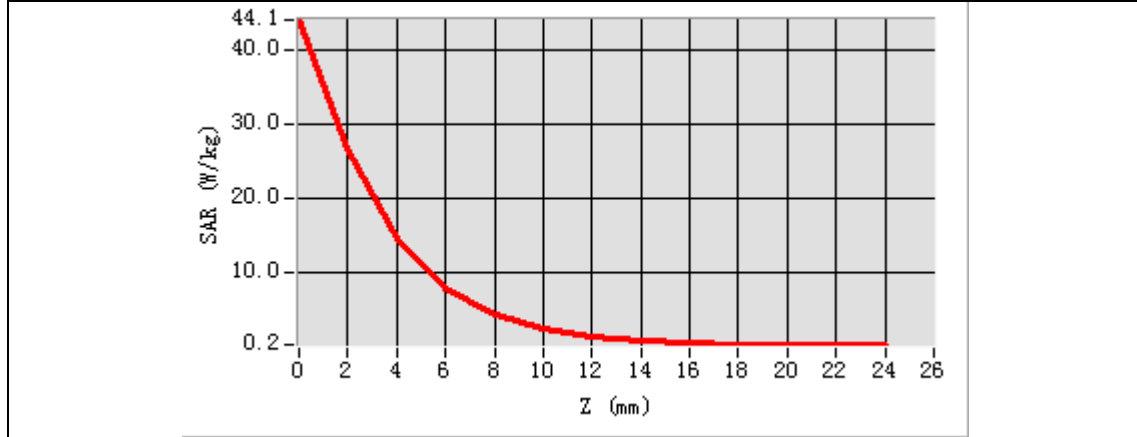

MEASUREMENT 4

Date of measurement: 4/7/2024

A. Experimental conditions.

Area Scan	<u>dx=10mm dy=10mm, h= 2.00 mm</u>
ZoomScan	<u>7x7x12,dx=4mm dy=4mm dz=2mm</u>
Phantom	<u>Validation plane</u>
Device Position	<u>Dipole</u>
Band	<u>CW5600</u>
Channels	<u>Middle</u>
Signal	<u>CW (Crest factor: 1.0)</u>
ConvF	<u>2.20</u>

B. SAR Measurement Results

Frequency (MHz)	5600.000000
Relative permittivity (real part)	34.495734
Relative permittivity (imaginary part)	15.996151
Conductivity (S/m)	4.976580
Variation (%)	-2.480000

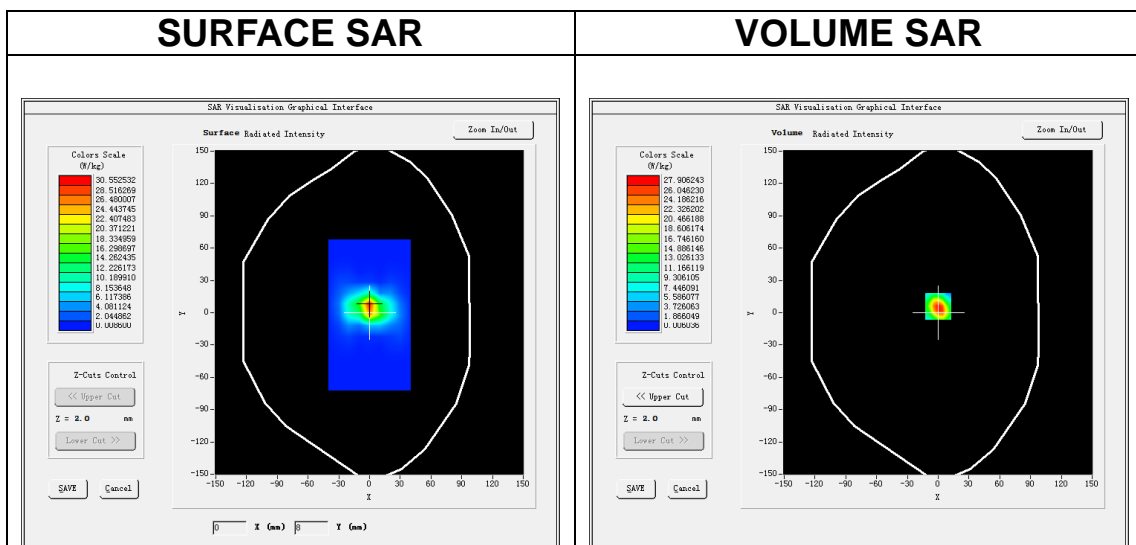

Maximum location: X=0.00, Y=6.00

SAR Peak: 51.23 W/kg

SAR 10g (W/Kg)	6.281030
SAR 1g (W/Kg)	17.255274

Z (m)	0.00	2.00	4.00	6.00	8.00	10.00	12.00	14.00	16.00	18.00	20.00	22.00
SA R (W/Kg)	54.193	31.965	16.377	8.1767	4.0825	3.8155	1.0324	0.4639	0.2755	0.1340	0.0731	0.0561

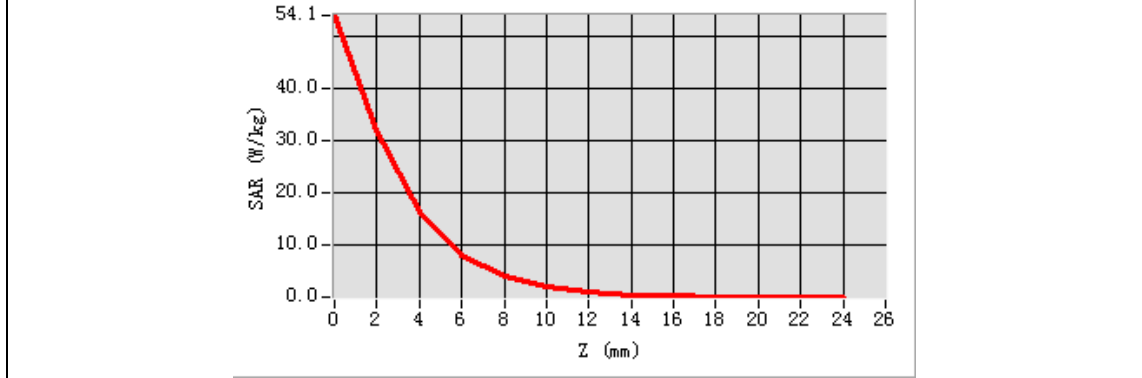

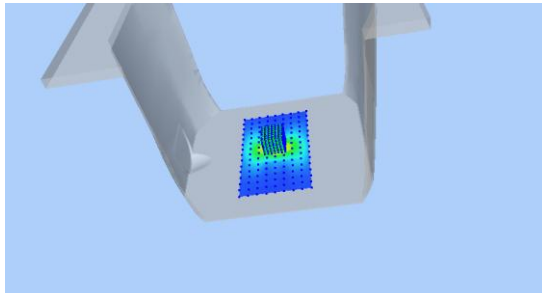
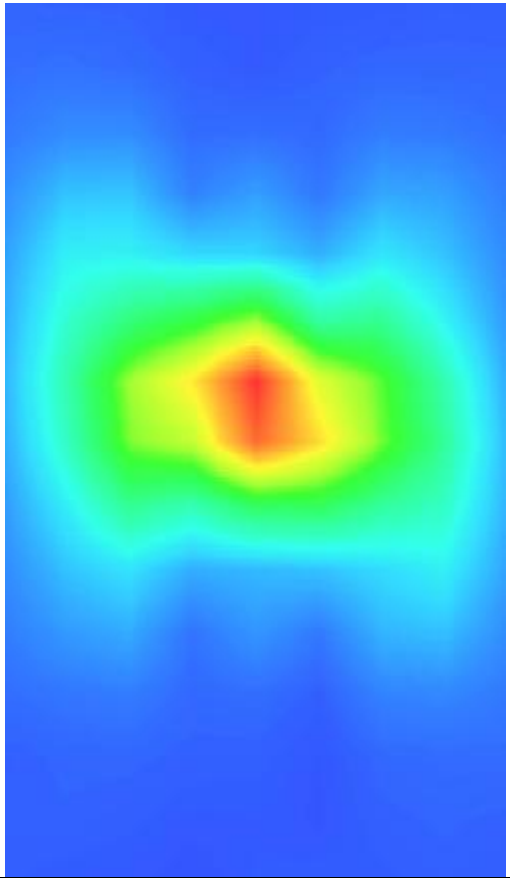
3D screen shot	Hot spot position
	

MEASUREMENT 5

Date of measurement: 26/6/2024

A. Experimental conditions.

Area Scan	<u>dx=10mm dy=10mm, h= 2.00 mm</u>
ZoomScan	<u>7x7x12,dx=4mm dy=4mm dz=2mm</u>
Phantom	<u>Validation plane</u>
Device Position	<u>Dipole</u>
Band	<u>CW5800</u>
Channels	<u>Middle</u>
Signal	<u>CW (Crest factor: 1.0)</u>
ConvF	<u>2.04</u>

B. SAR Measurement Results

Frequency (MHz)	5800.000000
Relative permittivity (real part)	34.157056
Relative permittivity (imaginary part)	16.182741
Conductivity (S/m)	5.214439
Variation (%)	-0.630000

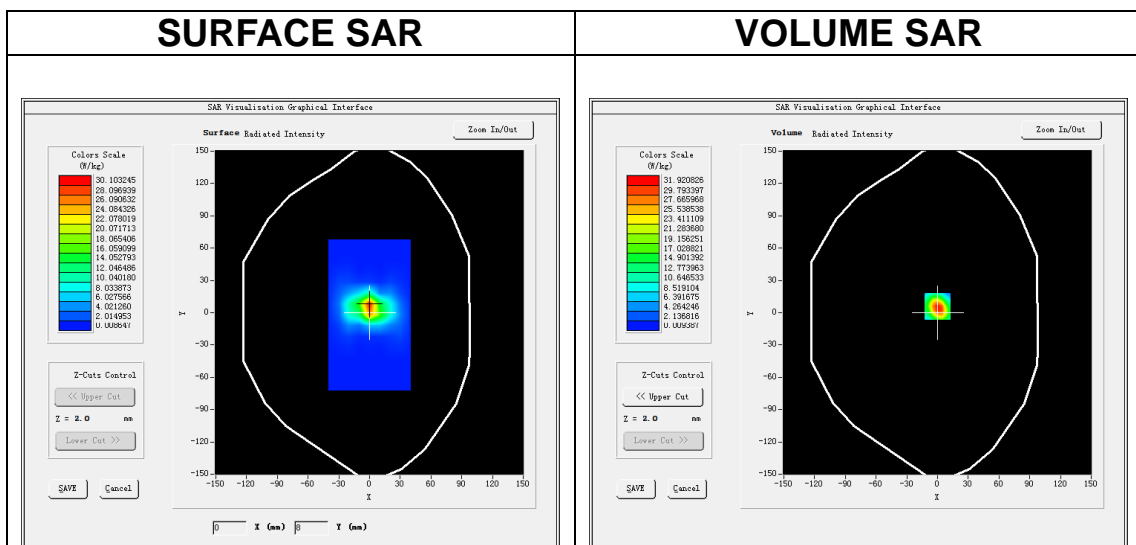

Maximum location: X=0.00, Y=6.00

SAR Peak: 57.37 W/kg

SAR 10g (W/Kg)	6.309102
SAR 1g (W/Kg)	18.253336

Z (m)	0.00	2.00	4.00	6.00	8.00	10.00	12.00	14.00	16.00	18.00	20.00	22.00
SAR (W/Kg)	54.037	31.920	16.180	8.1747	4.0878	2.0524	1.0388	0.5144	0.2732	0.1585	0.0756	0.0407

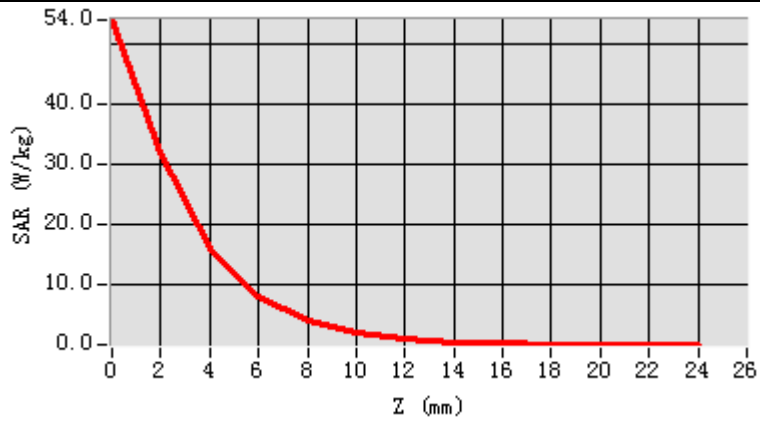

3D screen shot

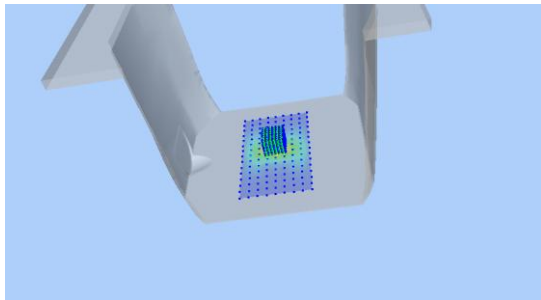

Hot spot position

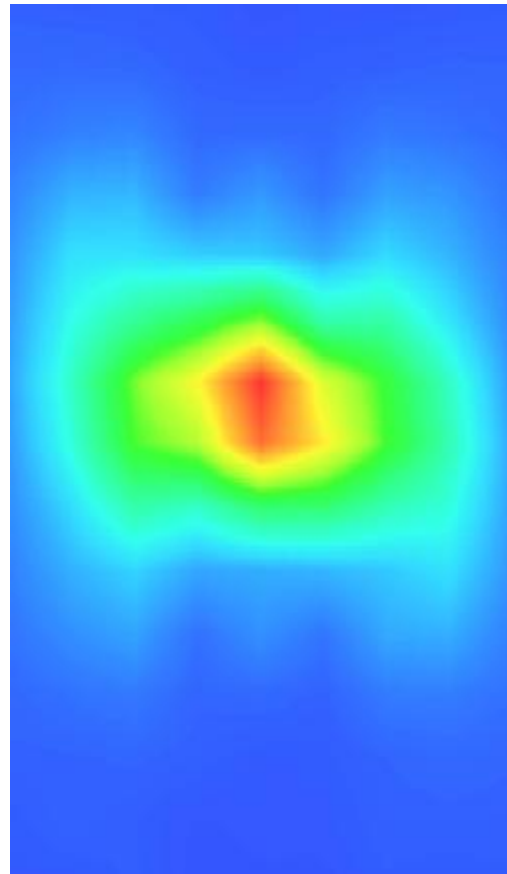

12. Appendix C. Plots of High SAR Measurement

Table of contents
MEASUREMENT 1 WLAN 5.2G Body ANT1
MEASUREMENT 2 WLAN 5.2G Body ANT2
MEASUREMENT 3 WLAN 5.3G Body ANT1
MEASUREMENT 4 WLAN 5.3G Body ANT2
MEASUREMENT 5 WLAN 5.6G Body ANT1
MEASUREMENT 6 WLAN 5.6G Body ANT2
MEASUREMENT 7 WLAN 5.8G Body ANT1
MEASUREMENT 8 WLAN 5.8G Body ANT2
MEASUREMENT 9 WLAN 2.4G Body ANT1
MEASUREMENT 10 WLAN 2.4G Body ANT2

MEASUREMENT 1

Date of measurement: 25/6/2024

A. Experimental conditions.

Area Scan	<u>dx=10mm dy=10mm, h= 2.00 mm</u>
ZoomScan	<u>7x7x12,dx=4mm dy=4mm dz=2mm</u>
Phantom	<u>Validation plane</u>
Device Position	<u>Body</u>
Band	<u>IEEE 802.11a U-NII</u>
Channels	<u>High</u>
Signal	<u>IEEE802.11a (Crest factor: 1.0)</u>
ConvF	<u>2.07</u>

B. SAR Measurement Results

Frequency (MHz)	5240.000000
Relative permittivity (real part)	34.571382
Relative permittivity (imaginary part)	15.807355
Conductivity (S/m)	4.601696
Variation (%)	2.970000

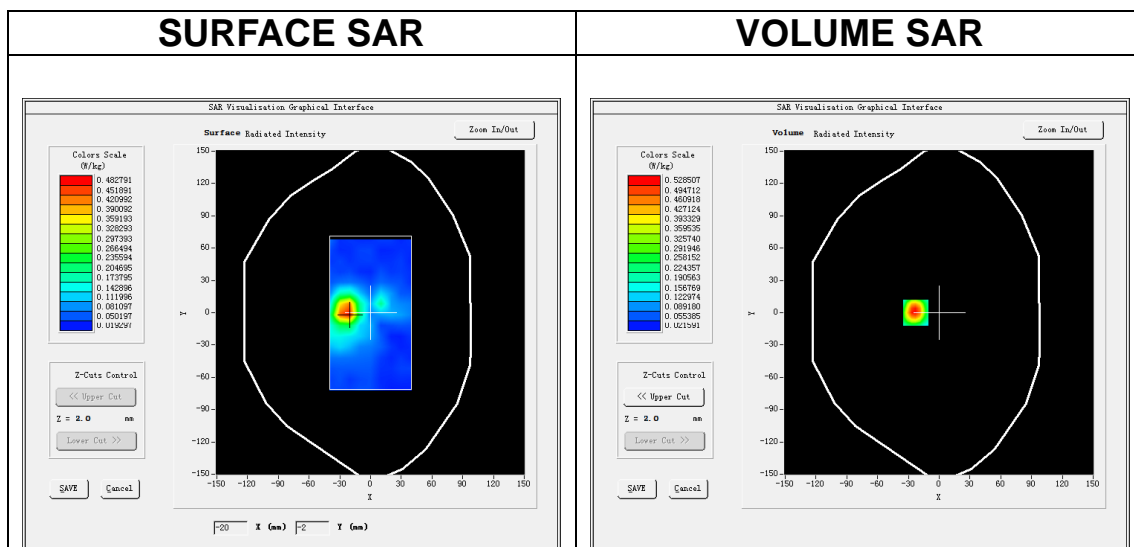

Maximum location: X=-23.00, Y=0.00
SAR Peak: 0.96 W/kg

SAR 10g (W/Kg)	0.132475
SAR 1g (W/Kg)	0.315802

Z (m)	0.00	2.00	4.00	6.00	8.00	10.00	12.00	14.00	16.00	18.00	20.00	22.00
SAR (W/Kg)	0.8970	0.5285	0.2602	0.1401	0.0797	0.0632	0.0356	0.0332	0.0267	0.0384	0.0273	0.0244

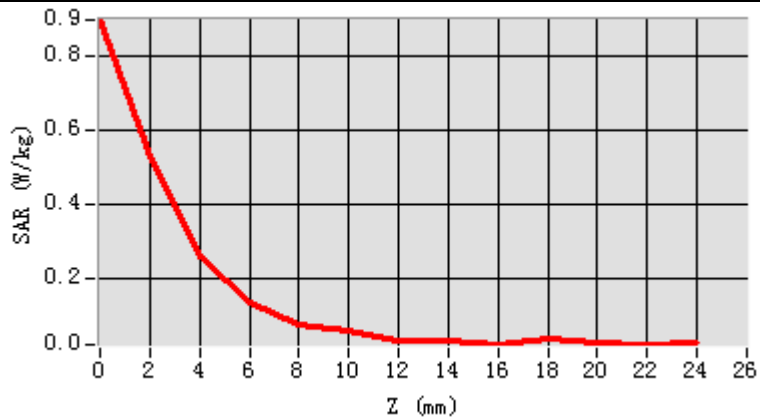

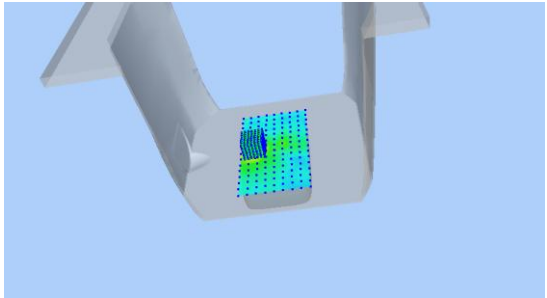
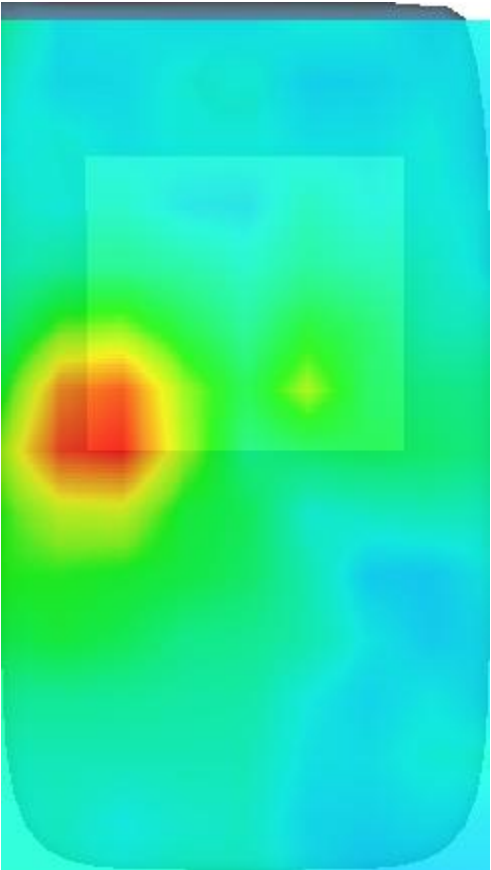
3D screen shot	Hot spot position
	

MEASUREMENT 2

Date of measurement: 25/6/2024

A. Experimental conditions.

Area Scan	<u>dx=10mm dy=10mm, h= 2.00 mm</u>
ZoomScan	<u>7x7x12,dx=4mm dy=4mm dz=2mm</u>
Phantom	<u>Validation plane</u>
Device Position	<u>Body</u>
Band	<u>IEEE 802.11ac U-NII</u>
Channels	<u>High</u>
Signal	<u>IEEE802.11ac (Crest factor: 1.0)</u>
ConvF	<u>2.07</u>

B. SAR Measurement Results

Frequency (MHz)	5240.000000
Relative permittivity (real part)	34.571382
Relative permittivity (imaginary part)	15.807355
Conductivity (S/m)	4.601696
Variation (%)	4.040000

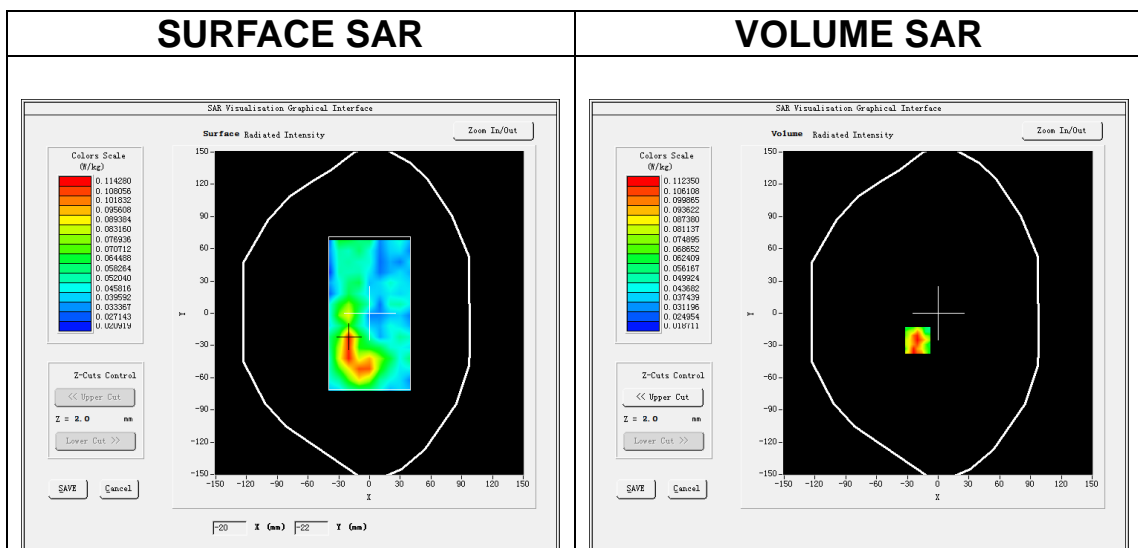

Maximum location: X=-20.00, Y=-25.00
SAR Peak: 0.19 W/kg

SAR 10g (W/Kg)	0.048187
SAR 1g (W/Kg)	0.074465

Z (m)	0.00	2.00	4.00	6.00	8.00	10.00	12.00	14.00	16.00	18.00	20.00	22.00
SAR (W/Kg)	0.2027	0.1124	0.0529	0.0424	0.0302	0.0280	0.0402	0.0384	0.0367	0.0303	0.0239	0.0263

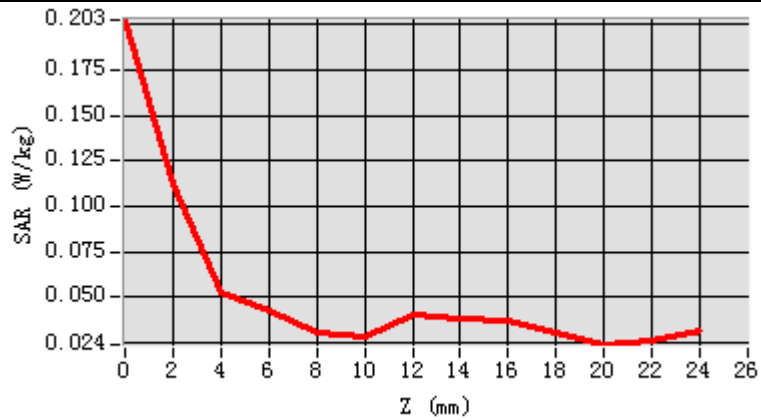

3D screen shot

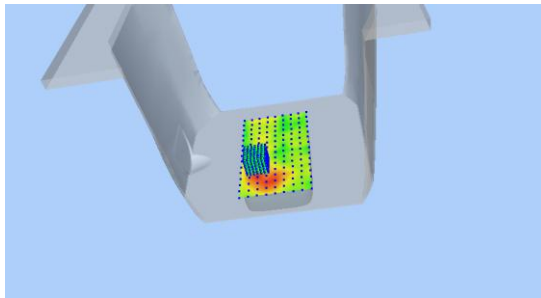

Hot spot position

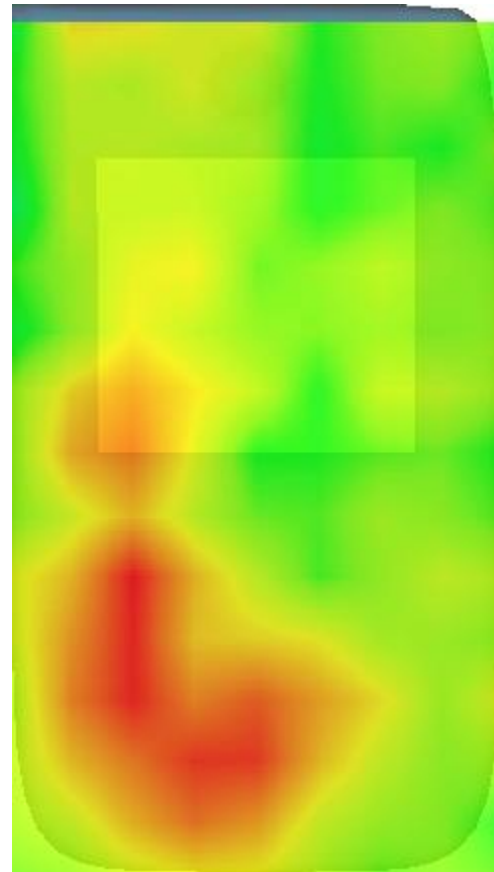

MEASUREMENT 3

Date of measurement: 3/7/2024

A. Experimental conditions.

Area Scan	<u>dx=10mm dy=10mm, h= 2.00 mm</u>
ZoomScan	<u>7x7x12,dx=4mm dy=4mm dz=2mm</u>
Phantom	<u>Validation plane</u>
Device Position	<u>Body</u>
Band	<u>IEEE 802.11n U-NII</u>
Channels	<u>High</u>
Signal	<u>IEEE802.11n (Crest factor: 1.0)</u>
ConvF	<u>2.11</u>

B. SAR Measurement Results

Frequency (MHz)	5310.000000
Relative permittivity (real part)	34.701495
Relative permittivity (imaginary part)	16.027455
Conductivity (S/m)	4.728099
Variation (%)	1.490000

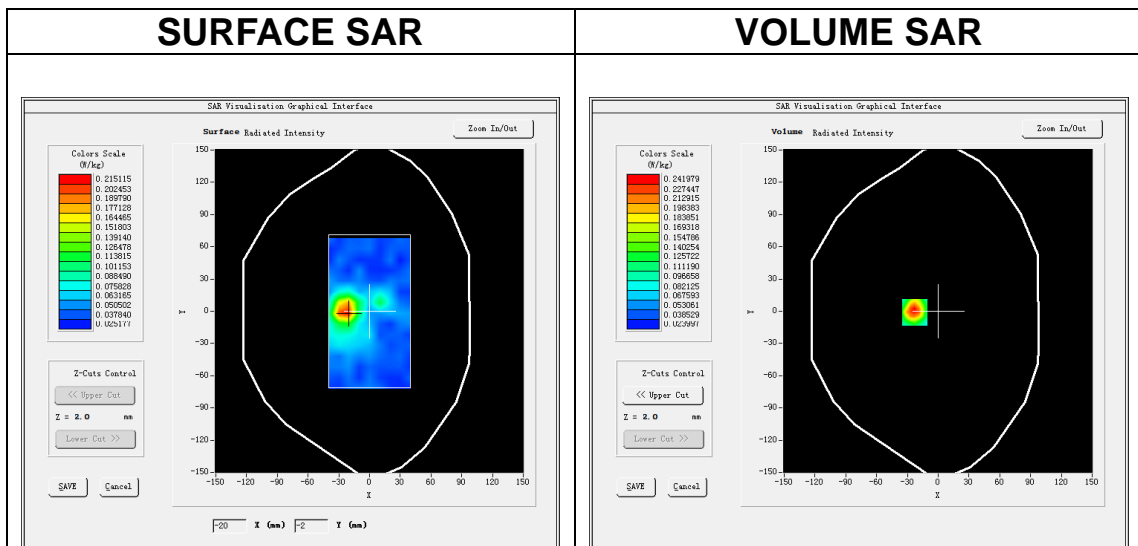

Maximum location: X=-23.00, Y=-1.00
SAR Peak: 0.43 W/kg

SAR 10g (W/Kg)	0.077928
SAR 1g (W/Kg)	0.151173

Z (m)	0.00	2.00	4.00	6.00	8.00	10.00	12.00	14.00	16.00	18.00	20.00	22.00
SAR (W/Kg)	0.4112	0.2420	0.1272	0.0739	0.0600	0.0473	0.0448	0.0404	0.0424	0.0405	0.0294	0.0378

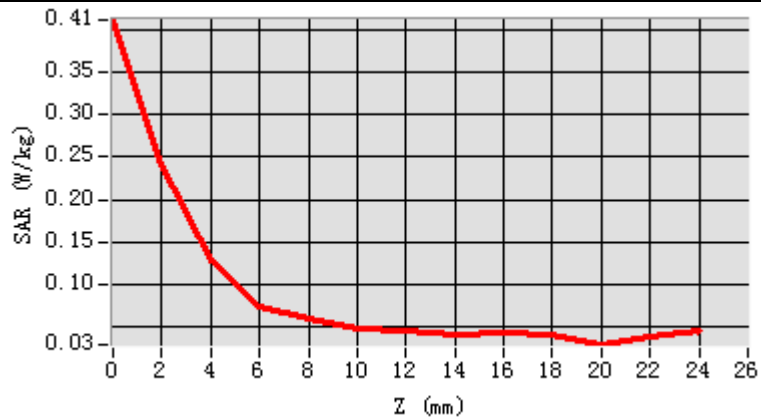

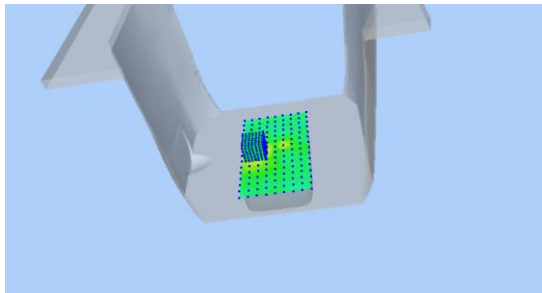
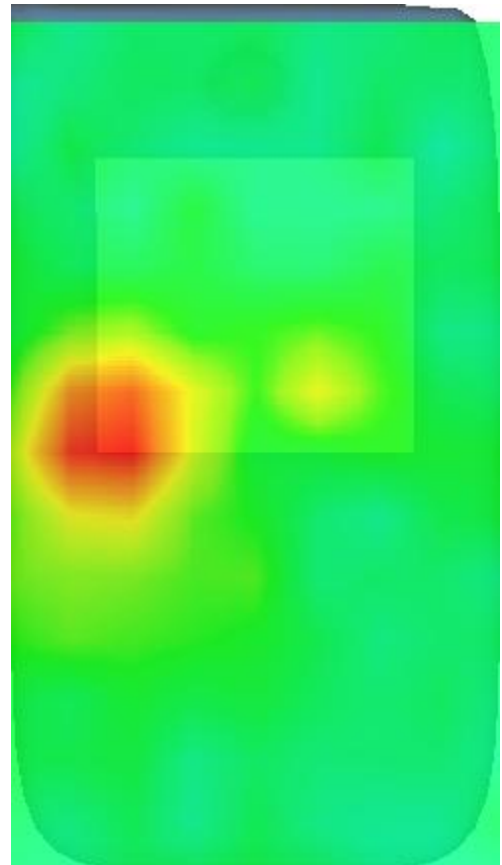
3D screen shot	Hot spot position
	

MEASUREMENT 4

Date of measurement: 3/7/2024

A. Experimental conditions.

Area Scan	<u>dx=10mm dy=10mm, h= 2.00 mm</u>
ZoomScan	<u>7x7x12,dx=4mm dy=4mm dz=2mm</u>
Phantom	<u>Validation plane</u>
Device Position	<u>Body</u>
Band	<u>IEEE 802.11a U-NII</u>
Channels	<u>High</u>
Signal	<u>IEEE802.11a (Crest factor: 1.0)</u>
ConvF	<u>2.11</u>

B. SAR Measurement Results

Frequency (MHz)	5320.000000
Relative permittivity (real part)	34.672532
Relative permittivity (imaginary part)	16.072852
Conductivity (S/m)	4.750420
Variation (%)	-3.389999

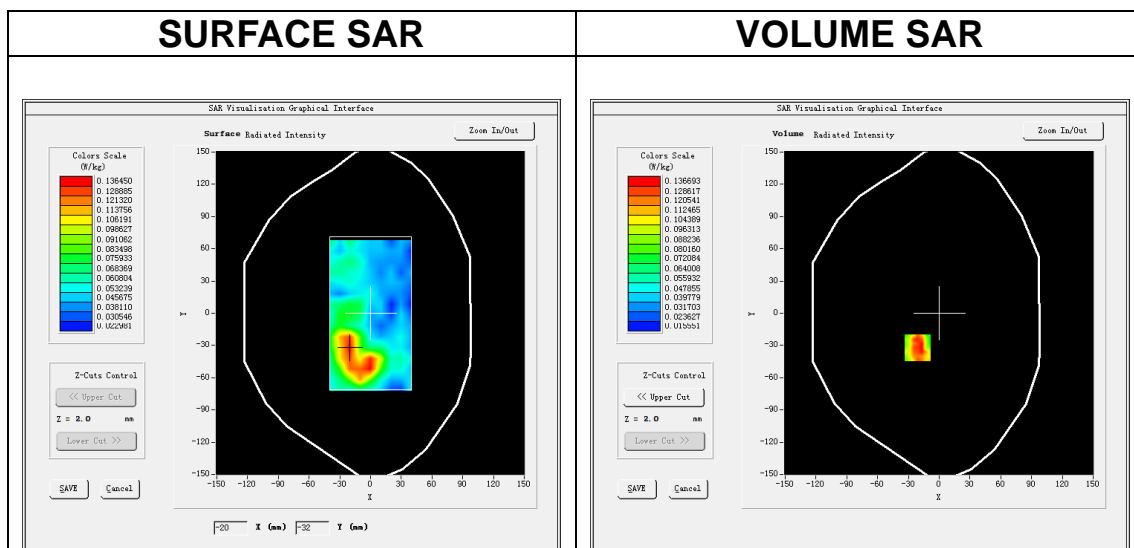

Maximum location: X=-21.00, Y=-32.00
SAR Peak: 0.24 W/kg

SAR 10g (W/Kg)	0.051077
SAR 1g (W/Kg)	0.087307

Z (m)	0.00	2.00	4.00	6.00	8.00	10.00	12.00	14.00	16.00	18.00	20.00	22.00
SAR (W/Kg)	0.2196	0.1367	0.0732	0.0489	0.0357	0.0343	0.0242	0.0180	0.0313	0.0225	0.0210	0.0195

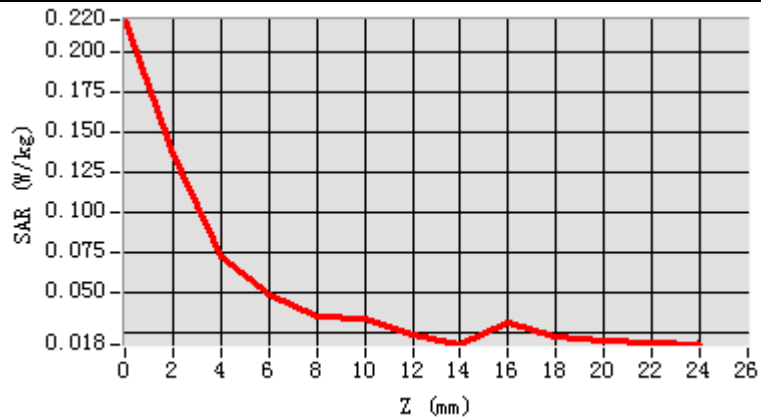

3D screen shot

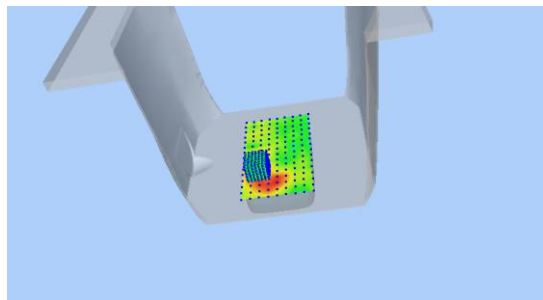

Hot spot position

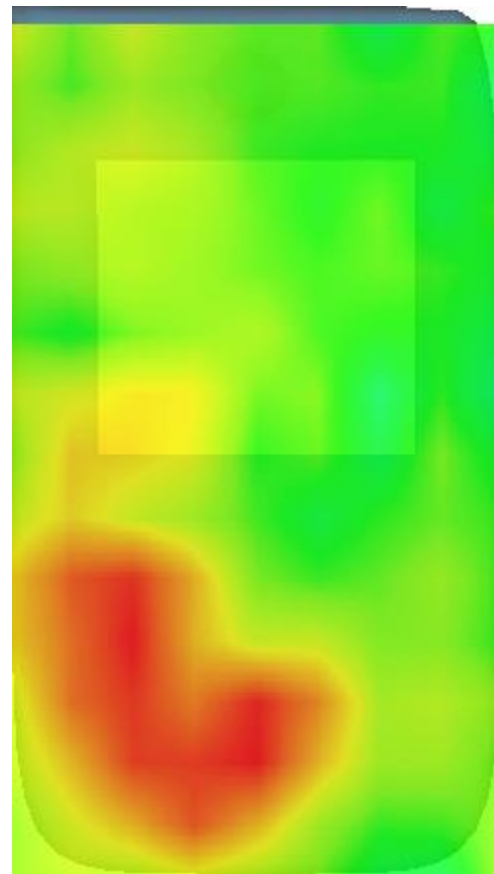

MEASUREMENT 5

Date of measurement: 4/7/2024

A. Experimental conditions.

Area Scan	<u>dx=10mm dy=10mm, h= 2.00 mm</u>
ZoomScan	<u>7x7x12,dx=4mm dy=4mm dz=2mm</u>
Phantom	<u>Validation plane</u>
Device Position	<u>Body</u>
Band	<u>IEEE 802.11n U-NII</u>
Channels	<u>Low</u>
Signal	<u>IEEE802.11n (Crest factor: 1.0)</u>
ConvF	<u>2.20</u>

B. SAR Measurement Results

Frequency (MHz)	5510.000000
Relative permittivity (real part)	34.821065
Relative permittivity (imaginary part)	15.891457
Conductivity (S/m)	4.864551
Variation (%)	-3.290000

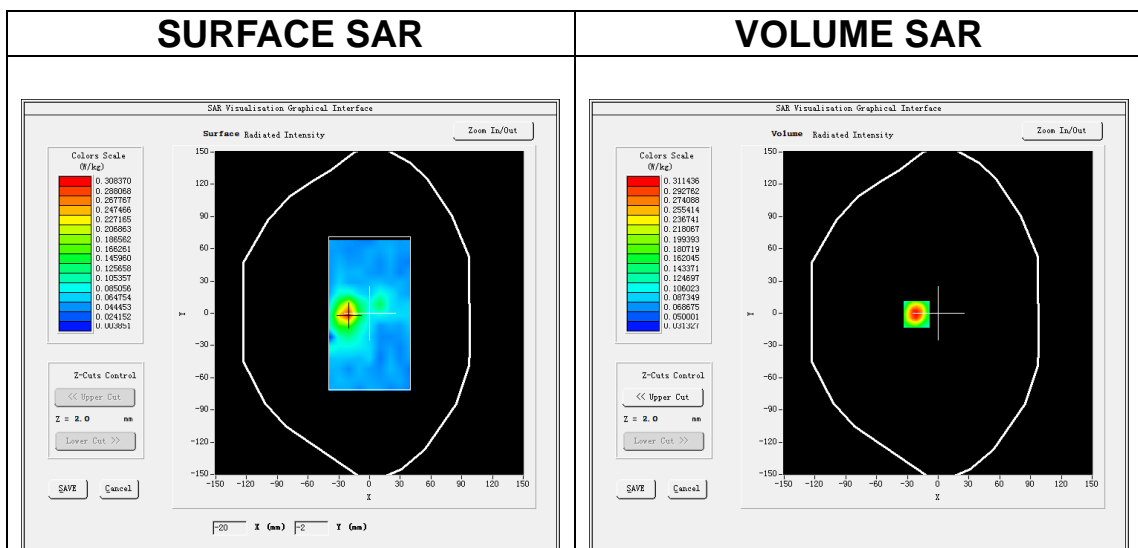

Maximum location: X=-21.00, Y=-1.00
SAR Peak: 0.56 W/kg

SAR 10g (W/Kg)	0.098649
SAR 1g (W/Kg)	0.198684

Z (m m)	0.00	2.00	4.00	6.00	8.00	10.00	12.00	14.00	16.00	18.00	20.00	22.00
SAR (W/Kg)	0.5184	0.3114	0.1652	0.0998	0.0699	0.0546	0.0500	0.0562	0.0364	0.0491	0.0411	0.0502

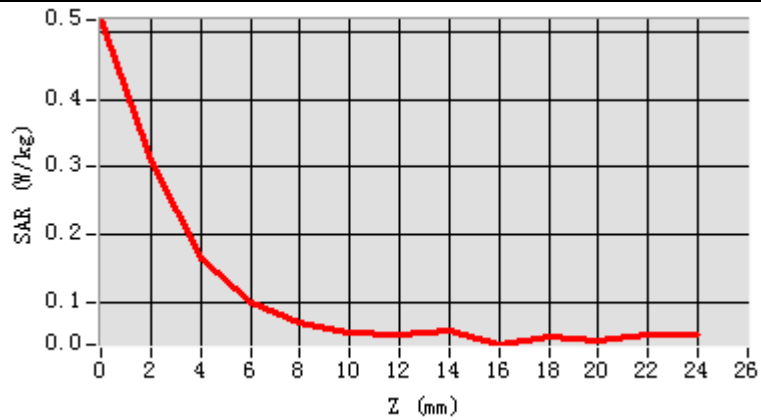

3D screen shot

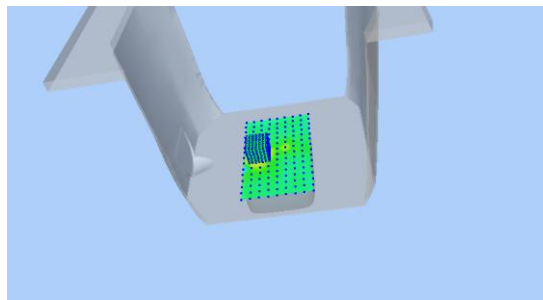

Hot spot position

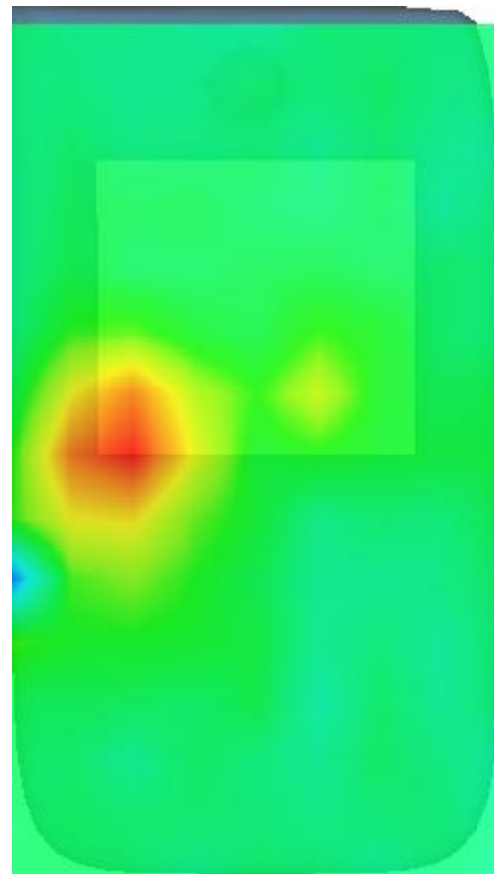

MEASUREMENT 6

Date of measurement: 4/7/2024

A. Experimental conditions.

Area Scan	<u>dx=10mm dy=10mm, h= 2.00 mm</u>
ZoomScan	<u>7x7x12,dx=4mm dy=4mm dz=2mm</u>
Phantom	<u>Validation plane</u>
Device Position	<u>Body</u>
Band	<u>IEEE 802.11n U-NII</u>
Channels	<u>Middle</u>
Signal	<u>IEEE802.11n (Crest factor: 1.0)</u>
ConvF	<u>2.20</u>

B. SAR Measurement Results

Frequency (MHz)	5600.000000
Relative permittivity (real part)	34.495735
Relative permittivity (imaginary part)	15.996151
Conductivity (S/m)	4.976580
Variation (%)	4.400000

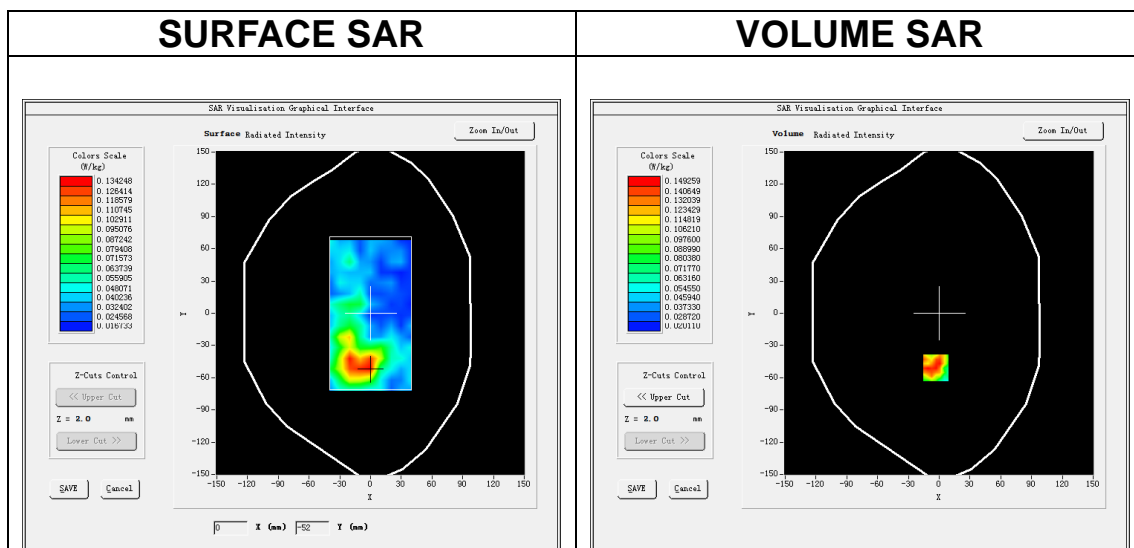

Maximum location: X=-3.00, Y=-51.00
SAR Peak: 0.29 W/kg

SAR 10g (W/Kg)	0.059687
SAR 1g (W/Kg)	0.096234

Z (m)	0.00	2.00	4.00	6.00	8.00	10.0	12.0	14.0	16.0	18.0	20.0	22.0
SAR (W/Kg)	0.2693	0.1493	0.0577	0.0417	0.0378	0.0253	0.0376	0.0403	0.0391	0.0261	0.0280	0.0334

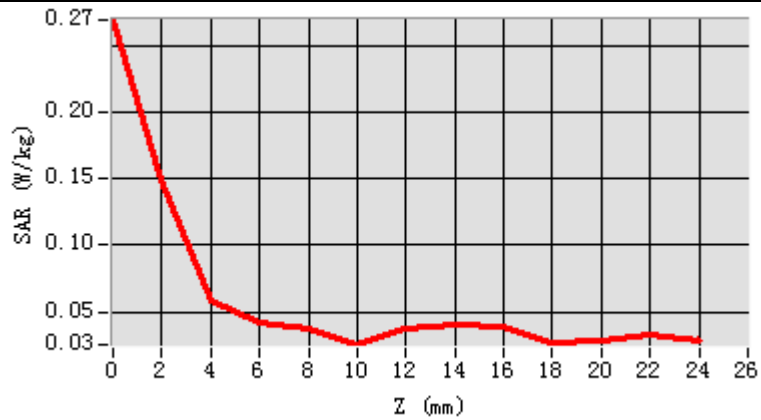

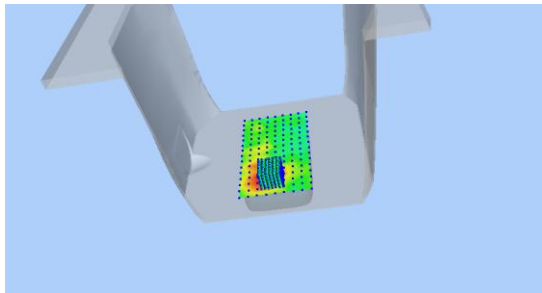
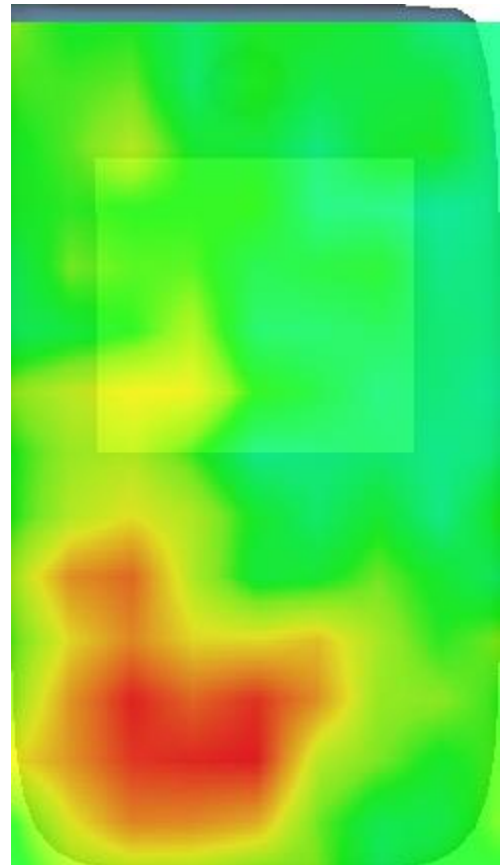
3D screen shot	Hot spot position
	

MEASUREMENT 7

Date of measurement: 26/6/2024

A. Experimental conditions.

Area Scan	<u>dx=10mm dy=10mm, h= 2.00 mm</u>
ZoomScan	<u>7x7x12,dx=4mm dy=4mm dz=2mm</u>
Phantom	<u>Validation plane</u>
Device Position	<u>Body</u>
Band	<u>IEEE 802.11ac U-NII</u>
Channels	<u>High</u>
Signal	<u>IEEE802.11ac (Crest factor: 1.0)</u>
ConvF	<u>2.04</u>

B. SAR Measurement Results

Frequency (MHz)	5795.000000
Relative permittivity (real part)	34.147264
Relative permittivity (imaginary part)	16.229417
Conductivity (S/m)	5.224970
Variation (%)	2.700000

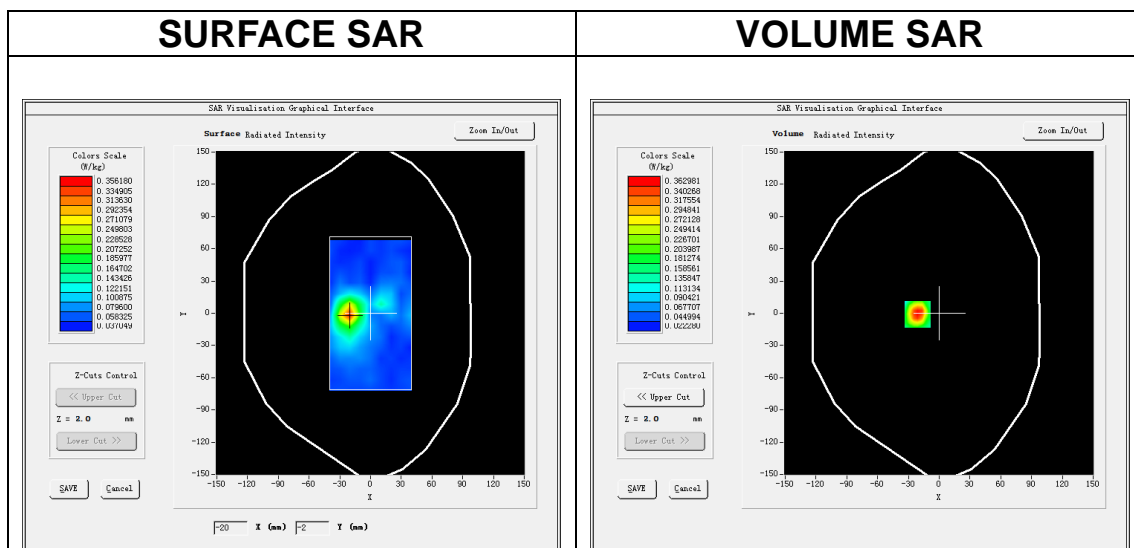

Maximum location: X=-21.00, Y=-1.00
SAR Peak: 0.64 W/kg

SAR 10g (W/Kg)	0.112318
SAR 1g (W/Kg)	0.227086

Z (m m)	0.00	2.00	4.00	6.00	8.00	10.00	12.00	14.00	16.00	18.00	20.00	22.00
SAR (W/Kg)	0.6121	0.3630	0.1962	0.0994	0.0794	0.0611	0.0556	0.0530	0.0553	0.0516	0.0611	0.0529

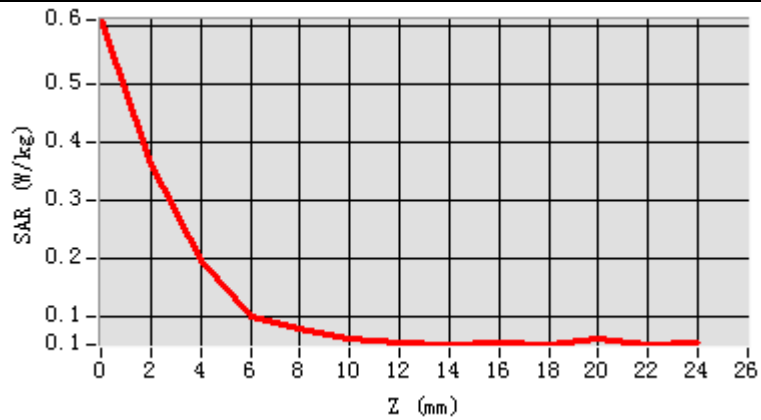

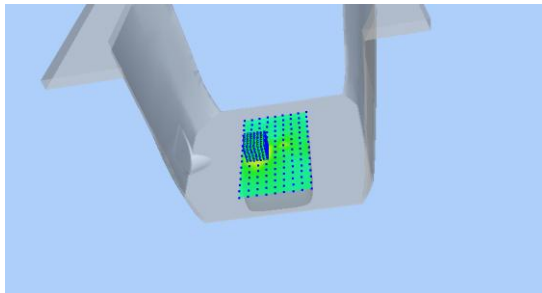
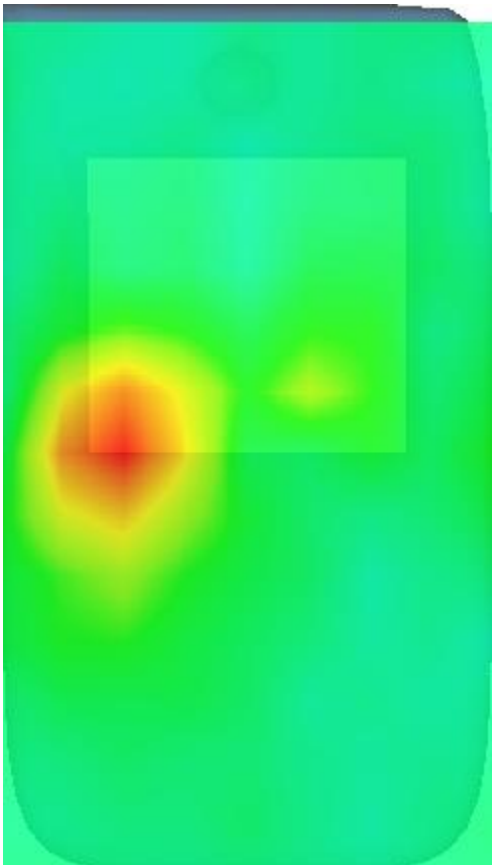
3D screen shot	Hot spot position
	

MEASUREMENT 8

Date of measurement: 26/6/2024

A. Experimental conditions.

Area Scan	<u>dx=10mm dy=10mm, h= 2.00 mm</u>
ZoomScan	<u>7x7x12,dx=4mm dy=4mm dz=2mm</u>
Phantom	<u>Validation plane</u>
Device Position	<u>Body</u>
Band	<u>IEEE 802.11ac U-NII</u>
Channels	<u>Middle</u>
Signal	<u>IEEE802.11ac (Crest factor: 1.0)</u>
ConvF	<u>2.04</u>

B. SAR Measurement Results

Frequency (MHz)	5775.000000
Relative permittivity (real part)	34.252077
Relative permittivity (imaginary part)	16.202177
Conductivity (S/m)	5.198198
Variation (%)	3.790000

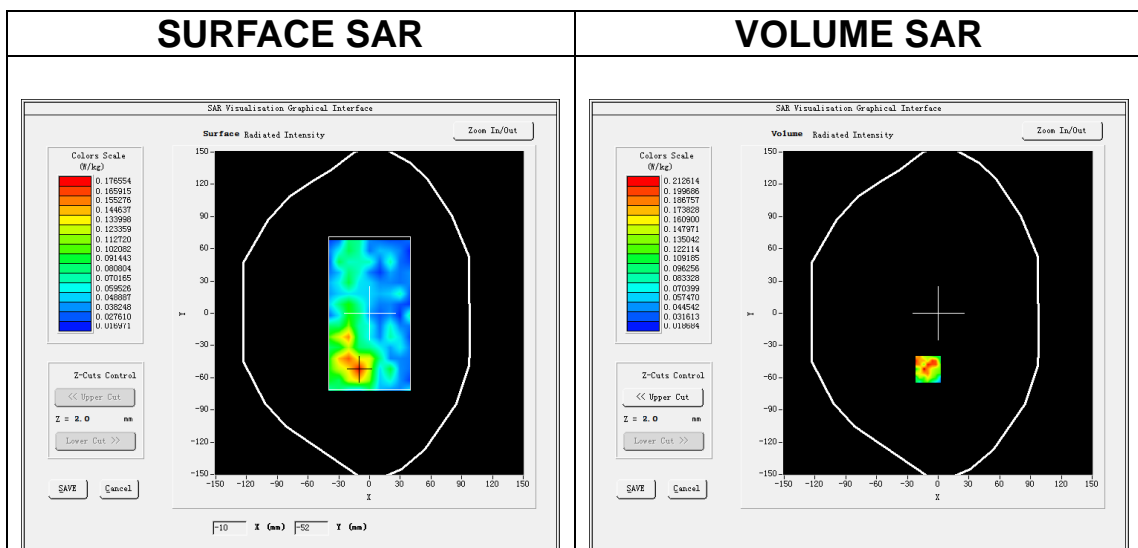

Maximum location: X=-10.00, Y=-52.00
SAR Peak: 0.44 W/kg

SAR 10g (W/Kg)	0.076417
SAR 1g (W/Kg)	0.128487

Z (m m)	0.00	2.00	4.00	6.00	8.00	10.00	12.00	14.00	16.00	18.00	20.00	22.00
SAR (W/Kg)	0.3936	0.2126	0.0867	0.0366	0.0728	0.0517	0.0714	0.0340	0.0535	0.0492	0.0361	0.0390

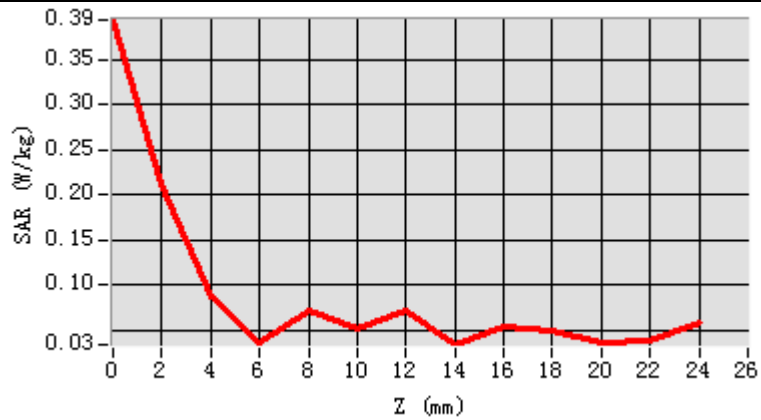

3D screen shot

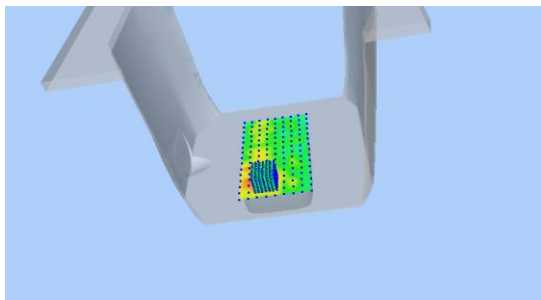

Hot spot position

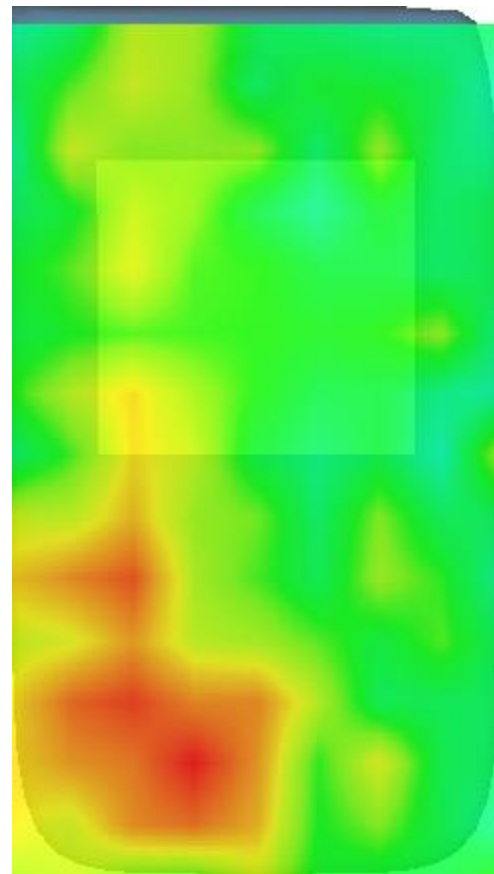

MEASUREMENT 9

Date of measurement: 5/7/2024

A. Experimental conditions.

Area Scan	<u>dx=12mm dy=12mm, h= 5.00 mm</u>
ZoomScan	<u>7x7x7,dx=5mm dy=5mm dz=5mm</u>
Phantom	<u>Validation plane</u>
Device Position	<u>Body</u>
Band	<u>IEEE 802.11b ISM</u>
Channels	<u>Middle</u>
Signal	<u>IEEE802.11b (Crest factor: 1.0)</u>
ConvF	<u>2.85</u>

B. SAR Measurement Results

Frequency (MHz)	2437.000000
Relative permittivity (real part)	37.743565
Relative permittivity (imaginary part)	12.886621
Conductivity (S/m)	1.744705
Variation (%)	-1.730000

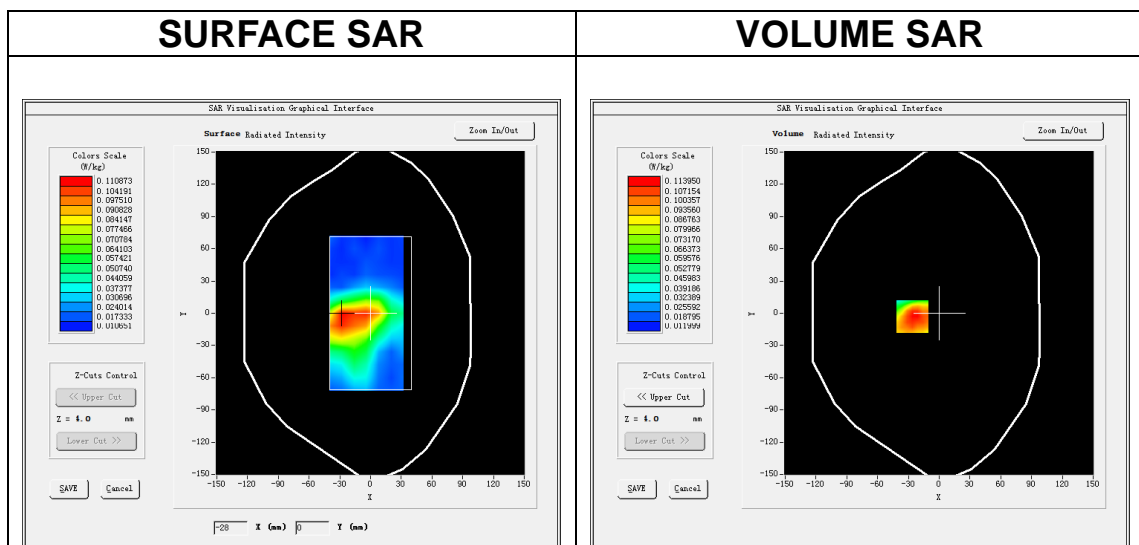

Maximum location: X=-26.00, Y=-3.00
SAR Peak: 0.18 W/kg

SAR 10g (W/Kg)	0.065118
SAR 1g (W/Kg)	0.109454

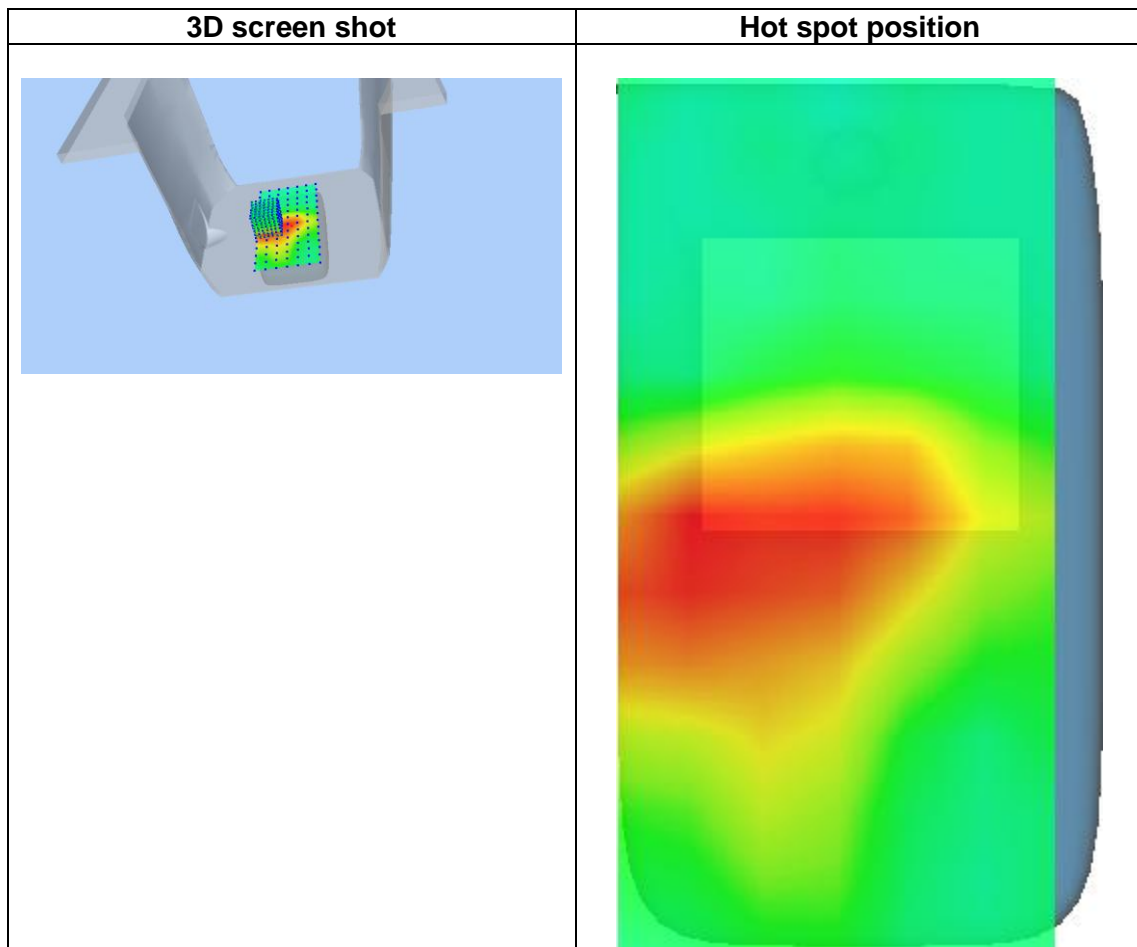
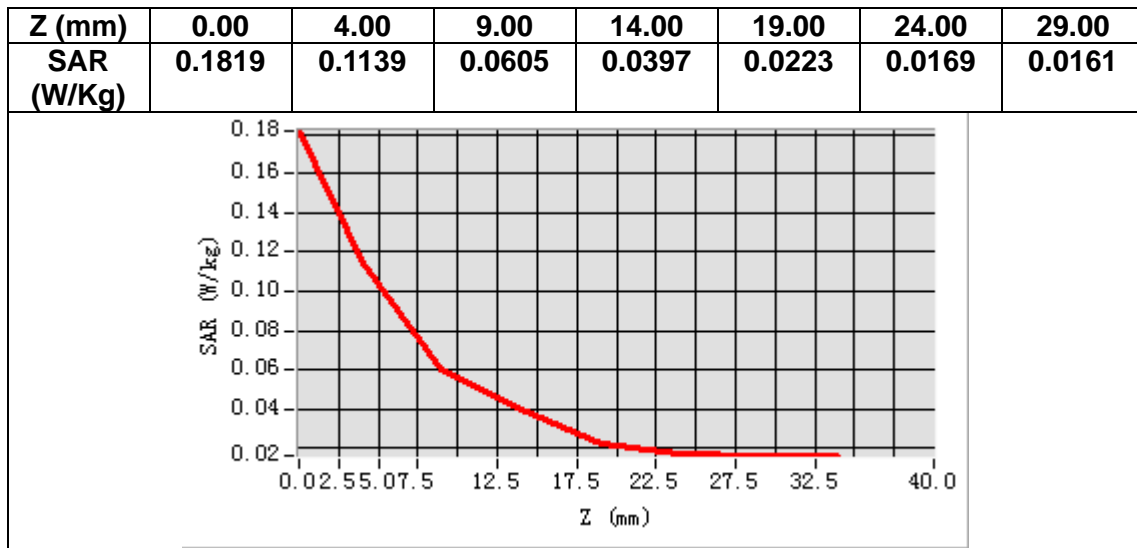

MEASUREMENT 10

Date of measurement: 5/7/2024

A. Experimental conditions.

Area Scan	<u>dx=12mm dy=12mm, h= 5.00 mm</u>
ZoomScan	<u>7x7x7, dx=5mm dy=5mm dz=5mm</u>
Phantom	<u>Validation plane</u>
Device Position	<u>Body</u>
Band	<u>IEEE 802.11b ISM</u>
Channels	<u>Middle</u>
Signal	<u>IEEE802.11b (Crest factor: 1.0)</u>
ConvF	<u>2.85</u>

B. SAR Measurement Results

Frequency (MHz)	2437.000000
Relative permittivity (real part)	37.743565
Relative permittivity (imaginary part)	12.886621
Conductivity (S/m)	1.744705
Variation (%)	2.680000

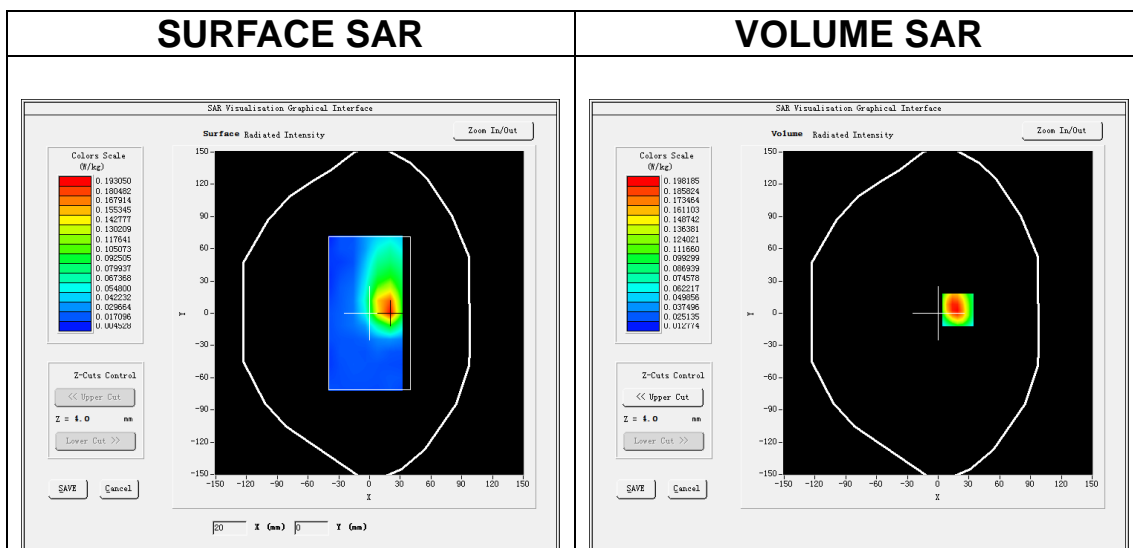

Maximum location: X=19.00, Y=3.00
SAR Peak: 0.32 W/kg

SAR 10g (W/Kg)	0.102752
SAR 1g (W/Kg)	0.186065

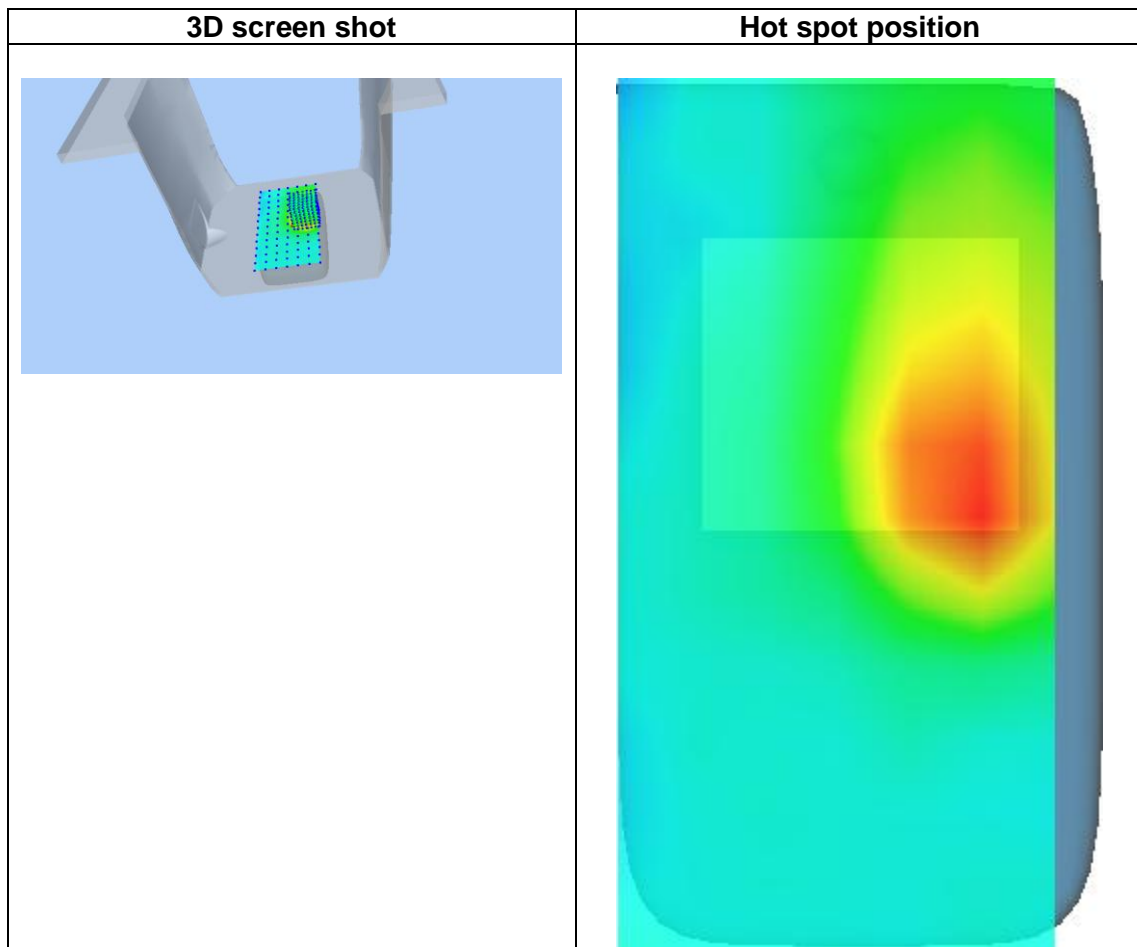
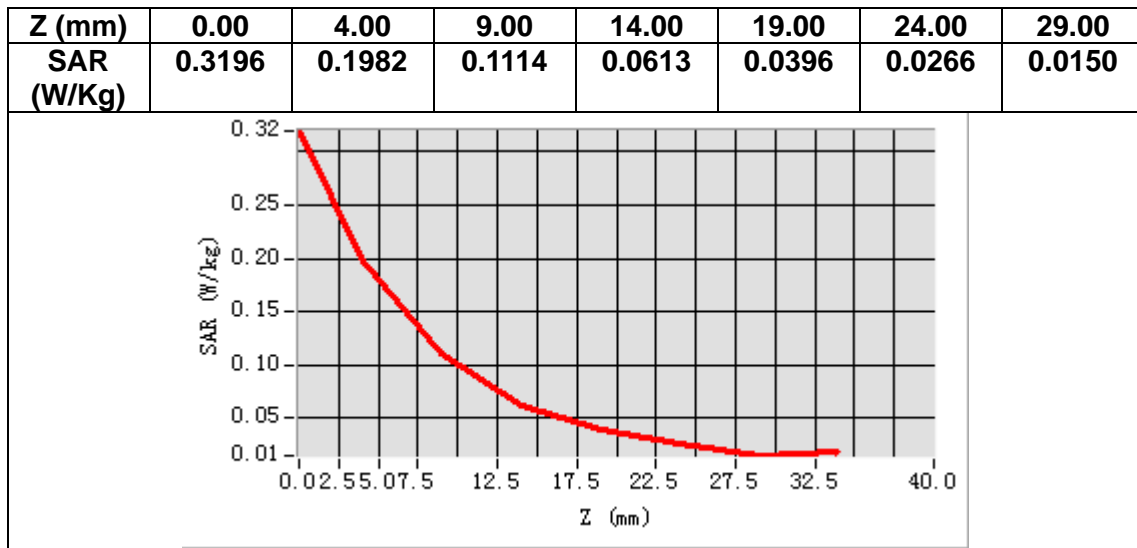

13. Appendix D. Calibration Certificate

Table of contents
E Field Probe - 3423-EPGO-426
2450 MHz Dipole - SN 03/15 DIP 2G450-352
5000-6000 MHz Dipole - SN 13/14 WGA 33



COMOSAR E-Field Probe Calibration Report

Ref : ACR.261.11.23.BES.A

**SHENZHEN NTEK TESTING TECHNOLOGY
CO., LTD.**

**BUILDING E, FENDA SCIENCE PARK, SANWEI
COMMUNITY, XIXIANG STREET,
BAO'AN DISTRICT, SHENZHEN GUANGDONG, CHINA
MVG COMOSAR DOSIMETRIC E-FIELD PROBE
SERIAL NO.: 3423-EPGO-426**

Calibrated at MVG

Z.I. de la pointe du diable

**Technopôle Brest Iroise – 295 avenue Alexis de Rochon
29280 PLOUZANE - FRANCE**

Calibration date: 09/18/2023



Accreditations #2-6789
Scope available on www.cofrac.fr

The use of the Cofrac brand and the accreditation references is prohibited from any reproduction.



Summary:

This document presents the method and results from an accredited COMOSAR Dosimetric E-Field Probe calibration performed at MVG, using the CALIPROBE test bench, for use with a MVG COMOSAR system only. The test results covered by accreditation are traceable to the International System of Units (SI).



COMOSAR E-FIELD PROBE CALIBRATION REPORT

Ref. ACR.261.11.23.BES.A

	<i>Name</i>	<i>Function</i>	<i>Date</i>	<i>Signature</i>
<i>Prepared by :</i>	Cyrille ONNEE	Measurement Responsible	9/18/2023	
<i>Checked & approved by:</i>	Jérôme Luc	Technical Manager	9/18/2023	
<i>Authorized by:</i>	Yann Toutain	Laboratory Director	9/19/2023	

Yann
Toutain ID 
Signature numérique de Yann Toutain ID
Date: 2023.09.19 09:08:14 +02'00'

	<i>Customer Name</i>
<i>Distribution :</i>	SHENZHEN NTEK TESTING TECHNOLOGY CO., LTD.

<i>Issue</i>	<i>Name</i>	<i>Date</i>	<i>Modifications</i>
A	Cyrille ONNEE	9/18/2023	Initial release



COMOSAR E-FIELD PROBE CALIBRATION REPORT

Ref: ACR.261.11.23.BES.A

TABLE OF CONTENTS

1	Device Under Test	4
2	Product Description	4
2.1	General Information	4
3	Measurement Method	4
3.1	Sensitivity	4
3.2	Linearity	5
3.3	Isotropy	5
3.4	Boundary Effect	5
4	Measurement Uncertainty	6
5	Calibration Results	6
5.1	Calibration in air	6
5.2	Calibration in liquid	7
6	Verification Results	8
7	List of Equipment	9



COMOSAR E-FIELD PROBE CALIBRATION REPORT

Ref: ACR.261.11.23.BES.A

1 DEVICE UNDER TEST

Device Under Test	
Device Type	COMOSAR DOSIMETRIC E FIELD PROBE
Manufacturer	MVG
Model	SSE2
Serial Number	3423-EPGO-426
Product Condition (new / used)	New
Frequency Range of Probe	0.15 GHz-7.5GHz
Resistance of Three Dipoles at Connector	Dipole 1: R1=0.261 MΩ Dipole 2: R2=0.213 MΩ Dipole 3: R3=0.233 MΩ

2 PRODUCT DESCRIPTION

2.1 GENERAL INFORMATION

MVG's COMOSAR E field Probes are built in accordance to the IEC/IEEE 62209-1528 and FCC KDB865664 D01 standards.



Figure 1 – MVG COMOSAR Dosimetric E field Probe

Probe Length	330 mm
Length of Individual Dipoles	2 mm
Maximum external diameter	8 mm
Probe Tip External Diameter	2.5 mm
Distance between dipoles / probe extremity	1 mm

3 MEASUREMENT METHOD

The IEC/IEEE 62209-1528 and FCC KDB865664 D01 standards provide recommended practices for the probe calibrations, including the performance characteristics of interest and methods by which to assess their effect. All calibrations / measurements performed meet the fore-mentioned standards.

3.1 SENSITIVITY

The sensitivity factors of the three dipoles were determined using a two step calibration method (air and tissue simulating liquid) using waveguides as outlined in the standards for frequency range 600-7500MHz and using the calorimeter cell method (transfer method) as outlined in the standards for frequency 150-450 MHz.



COMOSAR E-FIELD PROBE CALIBRATION REPORT

Ref. ACR.261.11.23.BES.A

3.2 LINEARITY

The evaluation of the linearity was done in free space using the waveguide, performing a power sweep to cover the SAR range 0.01 W/kg to 100W/kg.

3.3 ISOTROPY

The axial isotropy was evaluated by exposing the probe to a reference wave from a standard dipole with the dipole mounted under the flat phantom in the test configuration suggested for system validations and checks. The probe was rotated along its main axis from 0 to 360 degrees in 15-degree steps. The hemispherical isotropy is determined by inserting the probe in a thin plastic box filled with tissue-equivalent liquid, with the plastic box illuminated with the fields from a half wave dipole. The dipole is rotated about its axis (0°–180°) in 15° increments. At each step the probe is rotated about its axis (0°–360°).

3.4 BOUNDARY EFFECT

The boundary effect is defined as the deviation between the SAR measured data and the expected exponential decay in the liquid when the probe is oriented normal to the interface. To evaluate this effect, the liquid filled flat phantom is exposed to fields from either a reference dipole or waveguide. With the probe normal to the phantom surface, the peak spatial average SAR is measured and compared to the analytical value at the surface.

The boundary effect uncertainty can be estimated according to the following uncertainty approximation formula based on linear and exponential extrapolations between the surface and $d_{be} + d_{step}$ along lines that are approximately normal to the surface:

$$SAR_{uncertainty} [\%] = \Delta SAR_{be} \frac{(d_{be} + d_{step})^2}{2d_{step}} \frac{(e^{-d_{be}/(\delta/2)})}{\delta/2} \text{ for } (d_{be} + d_{step}) < 10 \text{ mm}$$

where

- $SAR_{uncertainty}$ is the uncertainty in percent of the probe boundary effect
- d_{be} is the distance between the surface and the closest *zoom-scan* measurement point, in millimetre
- Δ_{step} is the separation distance between the first and second measurement points that are closest to the phantom surface, in millimetre, assuming the boundary effect at the second location is negligible
- δ is the minimum penetration depth in millimetres of the head tissue-equivalent liquids defined in this standard, i.e., $\delta \approx 14 \text{ mm}$ at 3 GHz;
- ΔSAR_{be} in percent of SAR is the deviation between the measured SAR value, at the distance d_{be} from the boundary, and the analytical SAR value.

The measured worst case boundary effect SARuncertainty[%] for scanning distances larger than 4mm is 1.0% Limit ,2%).



COMOSAR E-FIELD PROBE CALIBRATION REPORT

Ref: ACR.261.11.23.BES.A

4 MEASUREMENT UNCERTAINTY

The guidelines outlined in the IEC/IEEE 62209-1528 and FCC KDB865664 D01 standards were followed to generate the measurement uncertainty associated with a SAR probe calibration using the waveguide or calorimetric cell technique depending on the frequency.

The estimated expanded uncertainty (k=2) in calibration for SAR (W/kg) is +/-11% for the frequency range 150-450MHz.

The estimated expanded uncertainty (k=2) in calibration for SAR (W/kg) is +/-14% for the frequency range 600-7500MHz.

5 CALIBRATION RESULTS

Ambient condition	
Liquid Temperature	20 +/- 1 °C
Lab Temperature	20 +/- 1 °C
Lab Humidity	30-70 %

5.1 CALIBRATION IN AIR

The following curve represents the measurement in waveguide of the voltage picked up by the probe toward the E-field generated inside the waveguide.

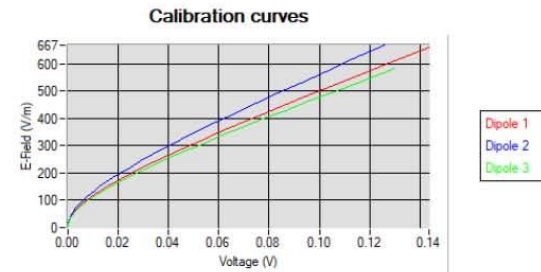

From this curve, the sensitivity in air is calculated using the below formula.

$$E^2 = \sum_{i=1}^3 \frac{V_i (1 + V_i / DCP_i)}{Norm_i}$$

where

Vi=voltage readings on the 3 channels of the probe

DCPi=diode compression point given below for the 3 channels of the probe

Normi=dipole sensitivity given below for the 3 channels of the probe



COMOSAR E-FIELD PROBE CALIBRATION REPORT

Ref: ACR.261.11.23.BES.A

Normx dipole 1 ($\mu\text{V}/(\text{V}/\text{m})^2$)	Normy dipole 2 ($\mu\text{V}/(\text{V}/\text{m})^2$)	Normz dipole 3 ($\mu\text{V}/(\text{V}/\text{m})^2$)
0.78	0.62	0.85

DCP dipole 1 (mV)	DCP dipole 2 (mV)	DCP dipole 3 (mV)
105	108	107

5.2 CALIBRATION IN LIQUID

The calorimeter cell or the waveguide is used to determine the calibration in liquid using the formula below.

$$ConvF = \frac{E_{liquid}^2}{E_{air}^2}$$

The E-field in the liquid is determined from the SAR measurement according to the below formula.

$$E_{liquid}^2 = \frac{\rho SAR}{\sigma}$$

where

σ =the conductivity of the liquid

ρ =the volumetric density of the liquid

SAR=the SAR measured from the formula that depends on the setup used. The SAR formulas are given below

For the calorimeter cell (150-450 MHz), the formula is:

$$SAR = c \frac{dT}{dt}$$

where

c =the specific heat for the liquid

dT/dt =the temperature rises over the time

For the waveguide setup (600-75000 MHz), the formula is:

$$SAR = \frac{4P_w}{ab\delta} e^{-\frac{2z}{\delta}}$$

where

a =the larger cross-sectional of the waveguide

b =the smaller cross-sectional of the waveguide

δ =the skin depth for the liquid in the waveguide

P_w =the power delivered to the liquid



COMOSAR E-FIELD PROBE CALIBRATION REPORT

Ref: ACR.261.11.23.BES.A

The below table summarize the ConvF for the calibrated liquid. The curves give examples for the measured SAR depending on the voltage in some liquid.

Liquid	Frequency (MHz*)	ConvF
HL750	750	2.37
HL850	835	2.32
HL900	900	2.23
HL1800	1800	2.45
HL1900	1900	2.63
HL2000	2000	2.83
HL2300	2300	2.81
HL2450	2450	2.85
HL2600	2600	2.65
HL3300	3300	2.21
HL3500	3500	2.20
HL3700	3700	2.11
HL3900	3900	2.40
HL4200	4200	2.40
HL4600	4600	2.33
HL4900	4900	2.37
HL5200	5200	2.07
HL5400	5400	2.11
HL5600	5600	2.20
HL5800	5800	2.04

(*) Frequency validity is +/-50MHz below 600MHz, +/-100MHz from 600MHz to 6GHz and +/-700MHz above 6GHz

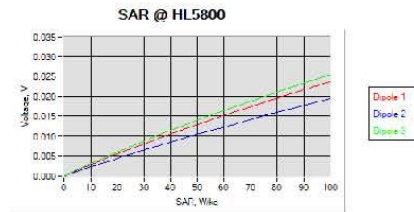
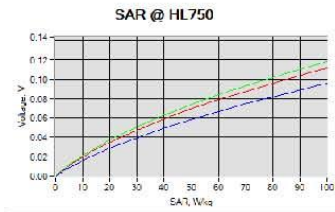

6 VERIFICATION RESULTS

The figures below represent the measured linearity and axial isotropy for this probe. The probe specification is +/-0.2 dB for linearity and +/-0.15 dB for axial isotropy.

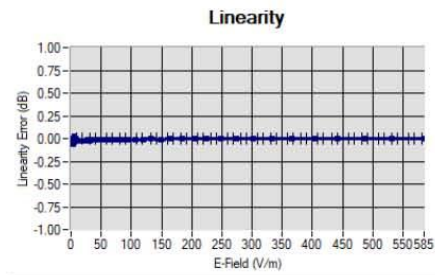

Linearity: +/-1.42% (+/-0.06dB)

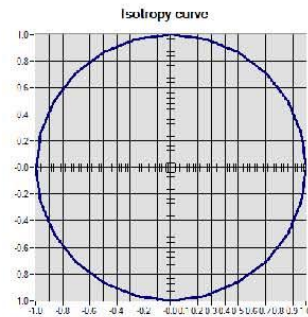

Isotropy: +/-0.21% (+/-0.01dB)



COMOSAR E-FIELD PROBE CALIBRATION REPORT

Ref. ACR.261.11.23.BES.A

7 LIST OF EQUIPMENT

Equipment Summary Sheet				
Equipment Description	Manufacturer / Model	Identification No.	Current Calibration Date	Next Calibration Date
CALIPROBE Test Bench	Version 2	NA	Validated. No cal required.	Validated. No cal required.
Network Analyzer	Rohde & Schwarz ZVM	100203	08/2021	08/2024
Network Analyzer	Agilent 8753ES	MY40003210	10/2019	10/2023
Network Analyzer – Calibration kit	HP 85033D	3423A08186	06/2021	06/2027
Network Analyzer – Calibration kit	Rohde & Schwarz ZV-Z235	101223	07/2022	07/2025
Multimeter	Keithley 2000	4013982	02/2023	02/2026
Signal Generator	Rohde & Schwarz SMB	106589	03/2022	03/2025
Amplifier	MVG	MODU-023-C-0002	Characterized prior to test. No cal required.	Characterized prior to test. No cal required.
Power Meter	NI-USB 5680	170100013	06/2021	06/2024
Power Meter	Keysight U2000A	SN: MY62340002	10/2022	10/2025
Directional Coupler	Krytar 158020	131467	Characterized prior to test. No cal required.	Characterized prior to test. No cal required.
Fluoroptic Thermometer	LumaSense Luxtron 812	94264	09/2022	09/2025
Coaxial cell	MVG	SN 32/16 COAXCELL_1	Validated. No cal required.	Validated. No cal required.
Waveguide	MVG	SN 32/16 WG2_1	Validated. No cal required.	Validated. No cal required.
Liquid transition	MVG	SN 32/16 WGLIQ_0G600_1	Validated. No cal required.	Validated. No cal required.

Page: 9/10

Template_ACR.DDD.N.YY.MVGB.ISSUE_COMOSAR_Probe_vL

This document shall not be reproduced, except in full or in part, without the written approval of MVG. The information contained herein is to be used only for the purpose for which it is submitted and is not to be released in whole or part without written approval of MVG.



COMOSAR E-FIELD PROBE CALIBRATION REPORT

Ref: ACR.261.11.23.BES.A

Waveguide	MVG	SN 32/16 WG4_1	Validated. No cal required.	Validated. No cal required.
Liquid transition	MVG	SN 32/16 WGLIQ_0G900_1	Validated. No cal required.	Validated. No cal required.
Waveguide	MVG	SN 32/16 WG6_1	Validated. No cal required.	Validated. No cal required.
Liquid transition	MVG	SN 32/16 WGLIQ_1G500_1	Validated. No cal required.	Validated. No cal required.
Waveguide	MVG	SN 32/16 WG8_1	Validated. No cal required.	Validated. No cal required.
Liquid transition	MVG	SN 32/16 WGLIQ_1G800B_1	Validated. No cal required.	Validated. No cal required.
Liquid transition	MVG	SN 32/16 WGLIQ_1G800H_1	Validated. No cal required.	Validated. No cal required.
Waveguide	MVG	SN 32/16 WG10_1	Validated. No cal required.	Validated. No cal required.
Liquid transition	MVG	SN 32/16 WGLIQ_3G500_1	Validated. No cal required.	Validated. No cal required.
Waveguide	MVG	SN 32/16 WG12_1	Validated. No cal required.	Validated. No cal required.
Liquid transition	MVG	SN 32/16 WGLIQ_5G000_1	Validated. No cal required.	Validated. No cal required.
Waveguide	MVG	SN 32/16 WG14_1	Validated. No cal required.	Validated. No cal required.
Liquid transition	MVG	SN 32/16 WGLIQ_7G000_1	Validated. No cal required.	Validated. No cal required.
Temperature / Humidity Sensor	Testo 184 H1	44225320	06/2021	06/2024



SAR Reference Dipole Calibration Report

Ref : ACR.53.29.24.BES.A

**SHENZHEN NTEK TESTING TECHNOLOGY
CO., LTD.**

**BUILDING E, FENDA SCIENCE PARK, SANWEI
COMMUNITY, XIXIANG STREET,
BAO'AN DISTRICT, SHENZHEN GUANGDONG, CHINA
MVG COMOSAR REFERENCE DIPOLE**

FREQUENCY: 2450 MHZ

SERIAL NO.: SN 03/15DIP2G450-352

Calibrated at MVG

Z.I. de la pointe du diable

Technopôle Brest Iroise – 295 avenue Alexis de Rochon

29280 PLOUZANE - FRANCE

Calibration date: 02/21/2024



Accreditations #2-6789 and #2-6814
Scope available on www.cofrac.fr

The use of the Cofrac brand and the accreditation references is prohibited from any reproduction.



Summary:

This document presents the method and results from an accredited SAR reference dipole calibration performed in MVG using the COMOSAR test bench. All calibration results are traceable to national metrology institutions.



SAR REFERENCE DIPOLE CALIBRATION REPORT

Ref : ACR.53.29.24.BES.A

	Name	Function	Date	Signature
Prepared by :	Pedro Ruiz	Measurement Responsible	2/22/2024	
Checked & approved by:	Jérôme Luc	Technical Manager	2/22/2024	
Authorized by:	Yann Toutain	Laboratory Director	2/27/2024	

Yann Toutain ID  Signature numérique de Yann Toutain ID
Date : 2024.02.27 08:57:39 +01'00'

	Customer Name
Distribution :	SHENZHEN NTEK TESTING TECHNOLOGY CO., LTD.

Issue	Name	Date	Modifications
A	Pedro Ruiz	2/22/2024	Initial release